

Vega IS

User manual



Welcome



Thank you for choosing a AETHRA® SpA. Product.

Inside you will find useful information to help you get the most out of the Aethra product.

The information contained in this document is the property of Aethra SpA., it is subject to change without notice and it shall in no way be binding for Aethra SpA
© Copyright Aethra Telecomunicazioni SpA 2007.

MS, Microsoft and NetMeeting are registered trade marks of Microsoft Corporation.
Windows is a trade mark of Microsoft Corporation.

All rights reserved.

Cod. 074201010GB Rev. 2 – April 2008.

Index













INDEX	3
SAFETY RULES	7
REGIONAL REQUIREMENTS	7
STATE OF CALIFORNIA PROP 65 WARNING	7
ENVIRONMENTAL WARD.....	7
SAFETY RULES FOR BATTERIES	8
CLEANING	8
WARNINGS	8
EN 55022 CLASS A COMPLIANCE	8
FCC 15 CLASS A COMPLIANCE.....	8
CE MARK.....	8
ABOUT THIS MANUAL	9
ABOUT GRAPHIC USER INTERFACE (GUI)	10
ABOUT VEGA® X5	11
PRELIMINARY	11
GENERAL INTRODUCTION.....	11
FEATURES AT A GLANCE.....	12
VEGA® X5 COMPONENTS	12
REMOTE CONTROL	13
Remote control	13
Remote control keys	14
Remote control alpha-numeric symbols to keys association.....	16
CABLING SCHEME	17
VIDEOCONFERENCE TIPS	18
SYSTEM POSITIONING AND INSTALLATION	19
“MODE” connector	19
CONNECTING THE AETHRA POD	20
OPERATION AND USE	21
FIRST TIME EQUIPMENT IS SWITCHED ON.....	21
Licence code insertion	21
Location parameters setting.....	22
MENU STRUCTURE	23
HOME PAGE.....	25
HOW TO MAKE A CALL	26





HOW TO MAKE A CALL FROM PHONEBOOK.....	27
AUDIO-VIDEO CALLS.....	28
TO RESELECT AN INCOMING OR OUTGOING CALL.....	29
TCS-4 MODE VIDEO CALL.....	29
AUDIO CALL.....	30
SECURE CONNECTIONS.....	30
HOW TO RECEIVE A CALL.....	30
DUAL VIDEO MODE (OPTION).....	31
Dual Video Connection.....	31
Dual Video Disconnection.....	32
PHONEBOOK.....	33
Entering Names in the Phonebook.....	33
Modifying and Erasing Phonebook Entries.....	34
Connecting to a global Remote Phonebook.....	34
VIDEO INPUT MANAGEMENT.....	35
VIDEO PRIVACY.....	36
CONTROLLING AUDIO.....	36
VIDEO CAMERA PRESETS.....	36
SYSTEM CONFIGURATION - SETTINGS.....	37
USER PREFERENCES.....	37
Control panel.....	38
General.....	38
Screensaver.....	38
Remote control.....	39
Call-Answer mode.....	40
General.....	40
H.323.....	40
H.320.....	41
Broadcast.....	41
Display Status Bar and Transparency.....	42
Customize colors.....	42
AUDIO – VIDEO – DATA.....	43
Audio.....	44
Inputs.....	44
Processing.....	44
Outputs.....	44
Video Quality.....	45
Cameras.....	46
Settings.....	46
Customize.....	46
Driver.....	46

Monitors	47
Settings	47
PIP-PaP	50
Plasma/LCD	52
Viewing modes	52
Data Channels.....	57
INSTALLATION	58
Terminal Settings.....	58
Network interfaces.....	59
IP configuration	59
IP Configuration	59
H323 Settings	62
SIP Settings	62
Services (<i>Web-Telnet, SNMP, Streaming</i>)	63
PPPoE.....	67
ISDN network interface (option).....	68
Access Configuration – ISDN BRI Euro	69
Access configuration – ISDN BRI National	69
Access configuration – ISDN PRI Euro	70
Access configuration – ISDN PRI National.....	71
NIC network interface (option).....	72
G.703 interface configuration (option whit license)	72
NIC (V.35/RS449/RS530/X21) Interface Configuration (Licence Required—see “Licences” for more information).....	73
Enable network.....	73
Location.....	74
Load default settings.....	75
Licenses.....	75
Available options, under licence:.....	75
Encryption	76
Password.....	77
PRESENTATIONS.....	78
Slides storage.....	79
Slides recall via WEB client.....	79
Saving slides on a PC	79
INTEGRATED MULTI CONFERENCE UNIT – MCU – (OPTION).....	80
MCU Technical Specifications	80
Multiconference Setup.....	81
How to start a multiconference.....	82
Multiconference Management	85
MCU control panel icons.....	85
Terminals status during a MCU.....	88



Ending a Multiconference	88
Dual Video in MCU	89
SYSTEM DIAGNOSTICS	90
Terminal test.....	90
Interfaces	90
Connection Status	91
Hardware	91
Software Versions	91
CONNECTING A PERSONAL COMPUTER	92
CONNECTING A PC TO THE SYSTEM WITHOUT LAN	92
CONNECTING TO THE SYSTEM VIA A PC IN A LAN	92
REMOTE MANAGEMENT	93
ACCESS TO THE WEB PAGE	93
Live Video Streaming.....	93
TOOLS Section	94
CHAT Section	94
UPDATING SOFTWARE	95
DATA CONFERENCE WITH MICROSOFT NETMEETING 3.XX	96
DOWNLOAD DATA CONFERENCE.....	96
Managing the DataConference software.....	97
APPENDICES	98
IP NETWORK REQUIREMENTS FOR VIDEOCOMMUNICATION.....	98
NAT – FIREWALL INTEROPERABILITY	98
WIRELESS CARDS	102
TECHNICAL SPECIFICS	103
TROUBLESHOOTING	104
GLOSSARY	105
USE AND STORAGE CONDITIONS.....	106

SAFETY RULES

	DEVICE IN CLASS I Always connect to a grounded socket.
	CAUTION: for the operator's safety, only use the mains adapter that has been provided with the device.
	CAUTION: the mains cable is used as a disconnecting device, use therefore an easily accessible outlet located near the device for the power supply connection. Never remove the mains plug while the device is connected.
	CAUTION: connect the ISDN port to a network termination only (NT1). It is absolutely forbidden to connect the system to an outdoor telecommunication line.
	CAUTION: connect the LAN port to an internal LAN circuit only. It is absolutely forbidden to connect the system to an outdoor telecommunication line.
	CAUTION: the microphone POD cable provided with the system must be used only with this system and must not be routed under carpets, through walls, within risers, or as part of building wiring systems.
	CAUTION: the ETHERNET cable provided with the system must be used only with this system and must not be routed under carpets, through walls, within risers, or as part of building wiring systems.
	CAUTION: the ISDN cable provided with the system must be used only with this system and must not be routed under carpets, through walls, within risers, or as part of building wiring systems.
	CAUTION: for the operator's safety, make sure that the Network interface is always inserted. If the Network Interface is not in place, do not remove the cover under any circumstances.
	CAUTION: This equipment will be inoperable when the mains power fails.
	CAUTION: the change from cold to hot environments can cause condensate to form inside the device. To avoid malfunctioning, wait at least 2 hours before connecting the device to the main power supply.
	CAUTION: in case of fire, do NOT use water to extinguish it.
	CAUTION: RISK OF ELECTRIC SHOCK The power supply used by this device involves lethal voltage levels.

	CAUTION: do not touch the internal parts of the device (and/or of the mains adapter).
	CAUTION: if objects or liquids leak into the device, disconnect the power supply cable IMMEDIATELY. Have it checked by an authorized technician before using the device again.
	CAUTION: contact an authorized technician/consultant for assistance.
	CAUTION: when making repairs, disconnect the device from the power supply.

Regional Requirements

	Laitte on liitettävä suojamaadoituskoskettimilla varustettuun pistorasiaan.
	Apparatet må tilkoples jordat stikkontakt.
	Apparaten skall anslutas till jordat uttag.

State of California Prop 65 warning

	WARNING : This product contains chemicals known to the State of California to cause cancer and/or birth defects or other reproductive harm. Wash hands after handling.
---	---

Environmental Ward

	This equipment must not be treated as household waste and should instead be handed over to the applicable collection point for the recycling of electrical and electronic equipment. With the correct disposal of this equipment, you will help prevent any potential negative consequences for the environment and human health, which could otherwise be caused by inappropriate handling of this product. For more detailed information about recycling this product, please contact your local city office, your household waste disposal company or the dealer where you purchased this product.
---	---





Safety Rules For Batteries

	<ul style="list-style-type: none"> • Risk of explosion if batteries are replaced by an incorrect battery type. Dispose of used batteries following the user instructions. • The batteries of this equipment must be disposed of by either a recycling company or a company qualified for the disposal of dangerous materials. The battery may also be disposed of in special recycling containers specifically for worn out battery (this may vary from country to country). • Only use the same type of battery that was originally provided with the equipment. • Replace the batteries when the remaining power charge significantly low. Do not recharge. • Do not use any damaged batteries. • Do not use the batteries for different reasons from those prescribed. • Do not short circuit the batteries (direct contact between + and – poles of the battery). This can happen accidentally during the maintenance of the equipment or the replacement of the worn out batteries. • Do not put the batteries close to flames, sparks, radiators, microwave ovens, fireplaces, direct sun light or other sources of heat. Do not throw the batteries into the fire. • Do not weld directly on the battery terminals. • Do not install the batteries with the polarity upside down. Please refer to the installation instructions for battery installation. • Do not damage the batteries in any way. Do not try to open or to pierce the batteries. • Avoid any accidental collision as it could cause the batteries to rupture and leak corrosive liquids or irritabile vapours. In such case disconnect the power immediately from the equipment and batteries. • In case the battery liquids comes into contact with your skin or garments, wash the area immediately with water. If it comes into contact with your eyes, wash immediately with plenty of water and contact either a doctor or the nearest first aid office immediately. • Keep away from the children's reach.
---	---

Cleaning

	<p>To clean the device use a dry soft cloth (or with a little bit of gentle detergent). Never use solvents, such as alcohol or gasoline, to avoid damaging the finish.</p>
---	--

Warnings

	<p>Many of the components used in this device are sensitive to electrostatic charge.</p>
	<p>When handling the connection cables, disconnect the power supply and avoid direct contact with the connector terminals.</p>
	<p>When handling electronic components, touch a grounded surface to eliminate any static electricity. If possible, wear a grounding arm band.</p>
	<p>Failure to comply with these warnings could cause permanent damage to this device.</p>

EN 55022 Class A Compliance

	<p>This is a Class A product. In a residential environment this product may cause radio interference. In such case the user may need to take adequate measures.</p>
---	---

FCC 15 Class A Compliance

	<p>This equipment has been tested and found to comply with the limits for a Class A digital device, pursuant to part 15 of the FCC Rules. These limits are designed to provide reasonable protection against harmful interference when the equipment is operated in a commercial environment. This equipment generates, uses and can radiate radio frequency energy and, if not installed and used in accordance with the instructions manual, may cause harmful interference to radio communications. Operation of this equipment in a residential area is likely to cause harmful interference in which case the user will be required to correct the interference at his own expense.</p>
---	--

CE Mark

	<p>Aethra S.p.A. hereby declares that this device complies with essential requirements and other relevant notes of R&TTE Directive 1999/5/EC. The declaration of conformity maybe obtained from: Aethra S.p.A. Via Matteo Ricci, 10 - 60126 Ancona – Italy www.aethra.com - aethra@aethra.com</p>
---	--

About this manual

Used symbols and syntax:

!	Symbol related information must be followed very carefully.
----------	--

Nota	_ Associated instructions give useful information.
1.	_ Instructions in a enumerated list must be accomplished following the reported order.
2.	_
A)	_ The list preceded by capital letters denotes:
B)	_ possible choices at a main level .
a)	_ The list preceded by small letters denotes:
b)	_ possible choices at a secondary level .
➤	_ The list preceded by an arrow denotes: a list of possible choices.
•	_ The list with a dot is a general list.
NAME	_ Words written in this way (and in capital letters) indicate: the <u>name of a page of the GUI</u> (Graphical User Interface)
Name	_ Words written in this way indicate: the <u>name of a function or a parameter present on the GUI</u> .
"Name"	_ Words written in this way indicate: particular <u>Hardware or Software functions</u> .
Name	_ Words written in this way indicate: the <u>name of a Key of the Remote Control</u> .

About graphic user interface (GUI)

All system configurations and functionalities can be activated inside GUI (Graphical User Interface) shown on the monitor.

Main elements inside a MENU page:

PAGE – any page inside graphic user interface (GUI).

HOME PAGE – main GUI page; from here you can access all system functionalities and/or configurations.

ICON – image or symbol inside a page, showing an available functionality or setting status.

STATUS BAR – the graphic horizontal bar displayed in all pages lower end. Inside the bar, depending on the page, images or symbols show available functionalities or settings status.

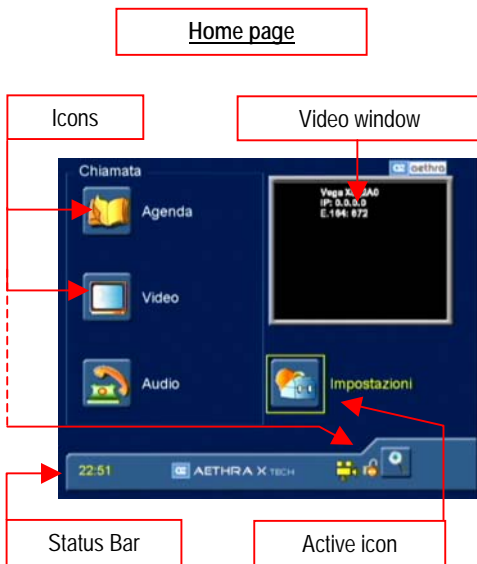

Inside a Menu you can:

SELECT AN ICON – to choose an icon use arrow keys, yellow frame showing the selection.

To activate the desired functionality, press OK.

Main functions of the system can be performed using:

- icons in the graphical user interface.
- remote control keys

About Vega[®] X5

Preliminary



ATTENTION !!! You have to insert SW licence enabling code (AETHRA SOFTWARE LICENCE KEY)

By pressing the “START” button, you’ll have 12 hours working time (switched on system time): at the end system will stop, waiting for the enabling code (see “Licences” §)

The System supports the complete functionality and all associated configurations that are described in this manual.

Some functionalities, being optional, need to be activated by a licence.

General introduction

Vega[®] X5 is a very high-performance system at the cutting-edge of set-top technology. It is ideal for medium and large-sized videoconferencing sessions that require enhanced audio and video quality.

The integrated Multipoint Conferencing Unit (MCU) connects up to 9 sites in mixed mode (ISDN and IP), with convenient Dial-out and Dial-in (Meet Me) configuration.

Highest Quality

Crystal clear audio and superior video quality at 4 Mbps

Enhances Collaboration

Built-in MCU connects up to 9 sites with Continuous Presence in mixed mode ISDN, IP-H.323 and IP-SIP.

Convenient

Fully featured set-top solution with embedded XGA ports and support for 3 monitors.

Supports multiple connectivity

Available in several versions: for connections up to 768 kbps over ISDN BRI and 4 Mbps over IP; as well as connections up to 2 Mbps over ISDN PRI or over leased lines (X.21, V.35, RS449, RS366, G.703).

Simultaneous Dual-Stream video

Convenient XGA inputs and outputs provide one-step PC plug-in for simultaneous dual-stream video and live PC presentation with enhanced images.

Easy to configure

Flexible, simple architecture enables easy re-configure of the system. Ready to upgrade simply by adding different cards. Change the channel aggregator card and upgrade from BRI to PRI in one easy step!

Patented Voice Tracking and Wideband audio

Voice Tracking technology enables the camera to automatically track and frame the person who is speaking. The first system to support both 14-kHz (ITU and ISO) wideband audio codecs adopted in videoconferencing.

Customizable Graphic User Interface

The user is able to choose layouts and colours from a variety of alternatives.

Features at a Glance

- XGA/DVI input and output ports.
- Dual-stream video.
- Support for three monitors.
- Supports ISDN, IP-H323, IP-SIP, PPPoE, leased networks.
- Mixed mode MCU with dial-out/dial-in configuration.
- Embedded PowerPoint® presentations.
- Camera with patented Voice Tracking.
- Supports AMX™ and Crestron™ protocols for keyboards and control panels.
- T.120 for multimedia.
- Full-duplex audio with echo cancellation.
- Automatic Noise Suppression.
- Remote diagnostics and management.
- Wireless LAN support.
- Web streaming function.

Vega® X5 components

Main components of the Vega X5 are:

- H.320/H323 system.
- Camera.
- Aethra High-Band POD.
- Power supply with cable.
- Infrared remote control.
- User manual.
- Cables for connection to a further monitor.
- DVI-I/XGA adapters.
- SCART adapter.
- PC serial cable adapter.
- LAN cables.
- Packaging.

NB:

The peripherals visible in the wiring system (see relevant chapter) that are not included in the above list are included as examples only.

Remote control

Note In order to avoid un-desired controls reaching other systems, user can modify transmission power from 2mt to 20mt (default) by means of a switch in the battery space:

Move both the Switches to - **ON** position → 20mt

Move both the Switches to - **OFF** (1,2) position → 2mt

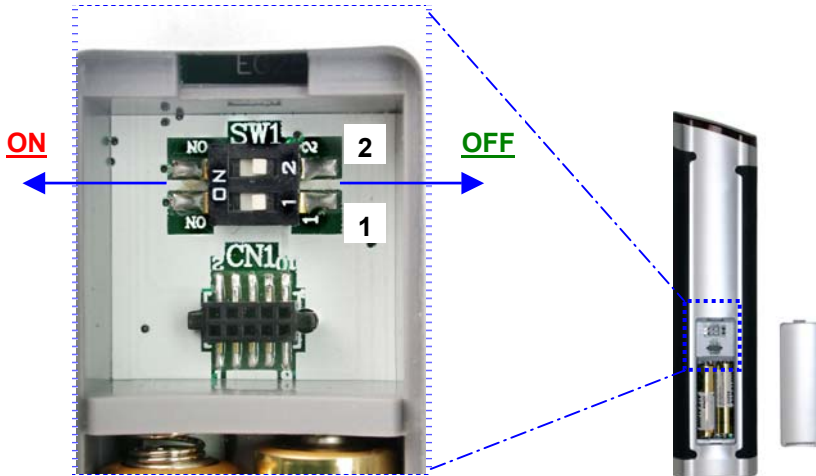

















Remote control





Remote control controls all system functions (see “Remote control” chapter)

Remote control uses 2 (two) 1.5V AAA alkaline batteries, and an alert appears on the status bar when batteries are low; user can change the batteries opening the cover on the remote control rear.

Remote control keys

Key	Description function
	<p>ON/OFF Key</p> <p>It turns on and off the system. It puts the system in "screen saver" mode. It restarts the system from the "screen saver" mode. By pressing the key results in opening a window of notice:</p> <ul style="list-style-type: none"> ➤ YES - Turn off the system. ➤ NO - To enter "screen saver" mode.
	<p>SEND Key</p> <p>It sends slides/still pictures.</p>
	<p>SLIDE Key</p> <p>Opens the integrated PPT presentation.</p>
	<p>FAR/NEAR Key</p> <p>Select the remote or local camera for PTZ.</p>
	<p>DUAL Key</p> <ul style="list-style-type: none"> ➤ Once in connection, it activates the DualVideo functionality: the system asks for the second video source. ➤ By pressing again the same key it is possible to stop the DualVideo, without disconnecting the call.
	<p>PIP Key</p> <ul style="list-style-type: none"> ➤ Activates/deactivates PIP (left upper corner being the PIP default position). ➤ If enabled, moves the PIP (See "Control panel" paragraph).
	<p>PRIVACY Key</p> <ul style="list-style-type: none"> ➤ Once in connection the system does not send any more video live but the customizable video privacy image. ➤ Not in connection activates/deactivates: Video privacy: As above. Don't disturb: System does not answer to incoming calls (busy for the remote).
	<p>Back Key</p> <p>Comes back to the previous interface page, without storing any parameter eventually modified.</p>

	<p>HOME Key Comes back to the Home interface page, saving any parameter eventually modified.</p>
	<p>SELF Key Activates/deactivates selfview.</p>
	<p>HELP Key Activates/deactivates on line help. During connections activates "Diagnostics".</p>
	<p>(- / +) Keys ➤ ZOOM: sets the camera zoom.</p> <p>Auto Key ➤ Activates/deactivates the autotracking function (NOT available).</p>
	<p>(- / +) Keys ➤ VOL: sets the audio level.</p> <p>Mute Key ➤ Activates/deactivates audio transmission.</p>
	<p>Arrow Keys ➤ allow navigation inside interface pages and camera movements.</p> <p>OK Key ➤ confirms actual selection.</p>
	<p>Call Key ➤ Allows to call or receive an incoming call.</p> <p>Disconnect Key ➤ Disconnects a call.</p> <p>Phonebook Key ➤ Opens the phonebook.</p>
	<p>Function Keys</p> <ul style="list-style-type: none"> ➤ Red - Camera choice shortcut. ➤ Yellow - Camera choice shortcut. ➤ Blue - H.243 function shortcut. ➤ Green - Received slides/still images visualization shortcut.
	<p>C-DEL Key ➤ Deletes characters.</p>

	<p>CAMERA Key</p> <ul style="list-style-type: none"> ➤ Selects a video input. ➤ Usable as camera choice shortcut. <p>(see “Audio-Video-Data chapter/Customize cameras”)</p>
	<p>MEMO-PRESET Key</p> <p>Saves the camera presets.</p>
	<p>SEL-PRESET Key</p> <p>Selects the camera presets.</p>
	<p>Alphanumeric Keys</p> <p>It allows letters and numbers insertion. (See the chart)</p>

Remote control alpha-numeric symbols to keys association

KEY	SYMBOLS				
1	1				
2	2	a	b	c	
3	3	d	e	f	
4	4	g	h	i	
5	5	j	k	l	
6	6	m	n	o	
7	7	p	q	r	s
8	8	t	u	v	
9	9	w	x	y	z
0	0	□			
*	.	*	=	-	+
#	#	@	:	/	\

Insertion of the characters in the alphanumeric fields

For numbers or letters insertion it is possible to use the alphanumeric keyboard of the remote control or, alternatively, the virtual keyboard by pressing the **OK** key once positioned on the alphanumeric field.

Select the “Esc” key in the virtual keyboard to close it.

Videoconference tips

Tips to improve a virtual meeting, to optimize audio-video transmission and reception, and to fully enjoy all videoconference benefits.

Optimal Meetings

- Before starting a videoconference be sure that all you need is ready: addresses or numbers to call, lighting, microphones.
- Connect and test all peripherals eventually needed (document camera, VCR, PC/Laptop)
- Use natural gestures as in a real meeting
- Speak in your normal voice

Optimal Video

- Avoid contemporaneous usage of natural (changing) and artificial lighting
- Avoid direct artificial lighting
- Avoid "mobile" backgrounds (curtains moved by the wind)
- Try to fill the screen as much as possible with persons, not backgrounds

Optimal Audio

- Place the microphone on the table in front of people (use 2 microphones in case of big tables)
- Do not place papers or other objects in front of the microphone
- Don't rustle papers or tap on the table or microphone
- Mute the microphone before moving it.
- Speak in your normal voice

System positioning and installation



All operations must be carried out without connection to main power supply. Connection to main power supply should only be performed after complete parts assembly.

Place the System in the desired location, and connect the follow equipments:

1. Connect the "Aethra High Band POD"
(see "Cabling Scheme", cable ①).
2. Connect:
"LINE OUTPUT" audio outputs to audio inputs of main monitor or to an amplifier,
"VGA/DVI-I" system main video output to main monitor input,
(see "Cabling Scheme", cable ②).
3. Connect the LAN input to the network.
(see "Cabling Scheme", cable ③).
4. Connect the ISDN inputs to the network terminations.
(see "Cabling Scheme", cable ④).



Connect the ISDN input (ISDN connector or network interface) only to a network termination (NT1). Do not connect the equipment to an external telecommunications line.

5. Connect supplementary audio or video equipments to the available inputs/outputs.
6. Connect the power supply.
(see "Cabling Scheme", cable ⑤).
7. Switch the monitor ON.
8. Press the switch on key on the System rear.
The system status LED on the front means:
 - **LED on:** System is on and normally operating.
 - **LED flashing:** System power is on, but the System is in "standby" mode.
 - **LED off:** System power is either off or not connected.
9. Wait for the main user interface to appear.



"MODE" connector

Using the MODE connector you can preset the auxiliary monitor directly on the SCART input.

Connecting the Aethra POD

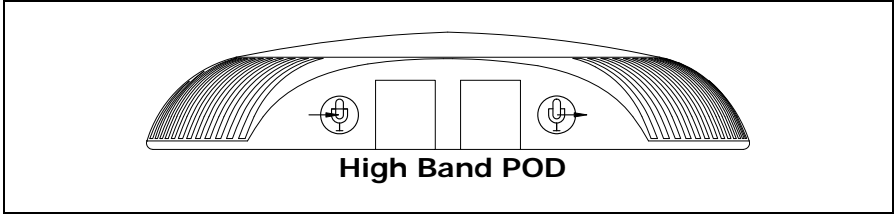
How to connect, the High Band Pod microphone.



1. Connect the High Band POD output  to the rear panel of the System.
2. In case a second High Band POD is used:
connect second POD  output to first POD  input.

NOTE

Max two (2) Aethra Pods can be used.

Operation and use

This section of the manual explains the basic functionality of the System. It is assumed that the system is correctly installed.

First time equipment is switched on



ATTENTION !!! You have to insert SW licence enabling code (AETHRA SOFTWARE LICENCE KEY)

First time the system is switched on, you need to:

1. insert the licence code;
2. Set some Location parameters.

Licence code insertion

When the equipment is switched on for the first time, the LICENCES page will appear on the screen, and you can insert the licence code.



Now several choices are available:

- A) You can insert the licence code and enable it by pressing the **Enable licence** button.
- B) You can go on using the system in TEMPORARY version by pressing the **Start** button; **LOCALIZATION** page will appear to set several important parameters (see "Localization" §) and you'll have 12 hours working time (switched on system time); once ended, system will stop waiting for the licence code.
In the status bar, below time indication, remaining working time is shown.
- C) insert a DEMO licence code and enable it by pressing the **Enable licence** button.
In the status bar, below time indication, remaining working time is shown.



Note: to insert licence code after B) and C) choices, see the "Licences" §.

Location parameters setting

Once the license code has been inserted, the LOCATION page is shown.



To ensure correct system operation, following parameters should be set:

- Country
- Video Standard
- Camera Frequency

Menu structure

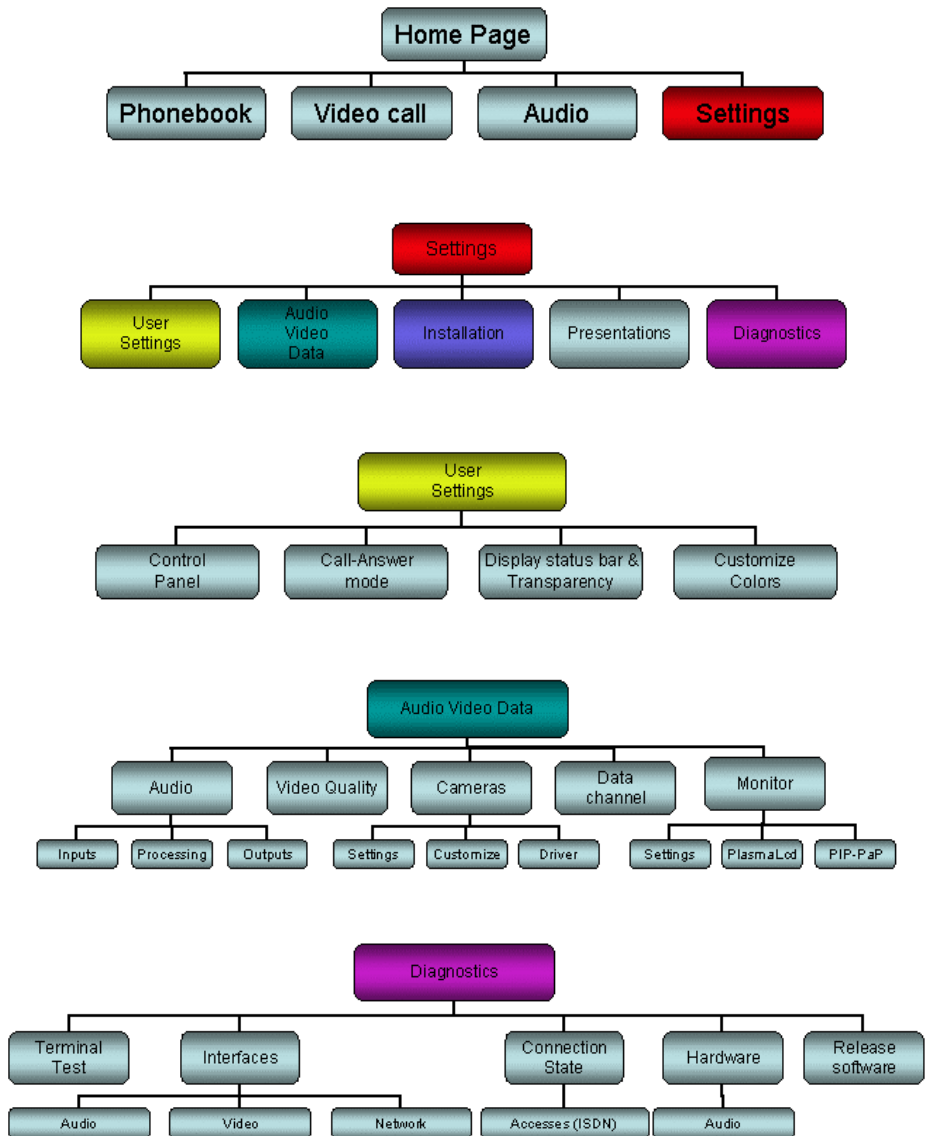

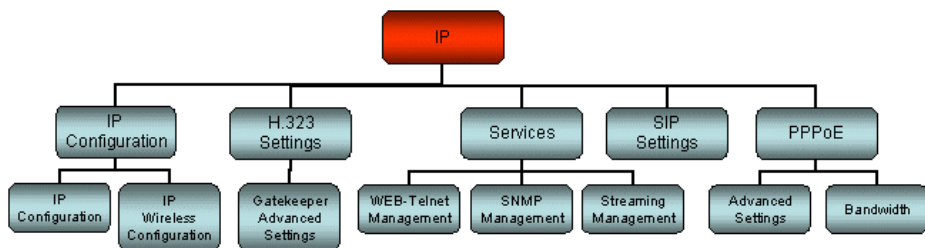
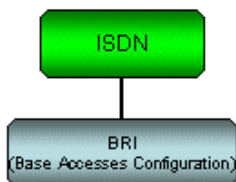
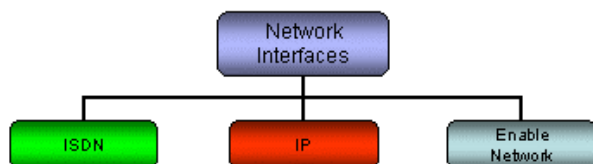
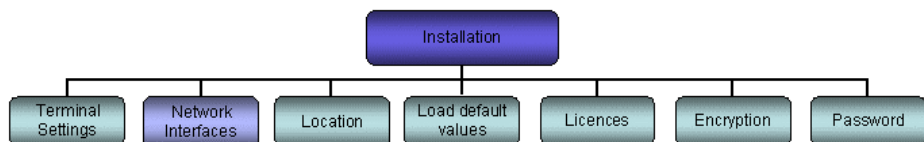

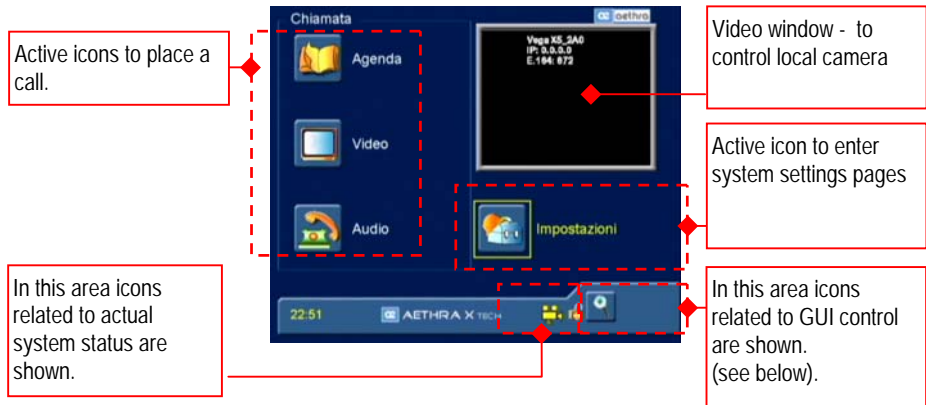

Home Page

Once switched on, the System shows main user interface, the **HOME PAGE**; from here you can place a **Call**, modify system **Settings**, and control system status by means of **Status Bar**.



In configuration menus, these icons will always appear:

	Back to previous page
	Back to HOME PAGE .
	Magnify in full screen the video live.

How to make a call

Once the System is on, the main user interface will display the **HOME PAGE**.

A call can be made in three different ways:

- From the Phonebook – see § “How to make a call from Phonebook”.
- Audio/Video – see § “Audio-video calls”.
- Audio Only – see § “Audio call”.



To make an IP call, the address of called IP terminal must be inserted following this syntax: xxx.xxx.xxx.xxx

How to make a call from Phonebook

To enable the quick selection of a number to call, a phonebook is available to store data about terminals that are frequently called. To call one of these numbers, users need only select the entry in a list.

From the **HOME PAGE**, using the **arrow** keys on the remote control device, move the pointer over the **Phonebook** icon and press **OK**.

The following image will appear:



Note:

The remote control has a dedicated key to directly open the phone book. See the “Remote Control” section.

To make a call:

1. Use **Search** field for an alphanumeric search.
2. Select the name and press **OK** to confirm.
3. Move to the **CALL** icon and press **OK** to make the call.
4. The same function can be achieved by pressing the **CALL** remote control key.
5. In order to end the call, use the **DISCONNECT** remote control key. The system will ask you to confirm disconnection.

Audio-video calls

From the **HOME PAGE**, select the **VIDEO** icon. The same function can be achieved by pressing the **CALL** key on the remote control.

You will enter the following page:



To complete the video call, please follow these steps:

1. Select the call type from the drop-down menu (ISDN, IP-H323, IP-SIP, NIC, MCU, MCU ISDN, MCU IP).
2. ISDN only: check or uncheck the **56K** box for multiple rates of 56Kbps or 64Kbps.
3. Select the call rate from the drop-down menu.

! To select an option from a drop-down menu, it is necessary to go to the menu itself, press **OK**, select the desired option by means of the remote control **arrows** and press **OK**.

4. Enter the number or user alias (the H.323 Name from the "H.323 Settings" menu) you want to call using either the alphanumeric keys on the remote control or the virtual keypad.

- !**
1. A virtual keypad can be activated for situations where you need to enter text (e.g. names for the phonebook or aliases for calls).
 2. To activate it, set the remote control **CURSOR** in the box where you want to enter text and press **OK**.
 3. Select the desired letter by moving the **CURSOR** over it, and pressing **OK**.
 4. To close the virtual keypad, select the **ESC** key and press **OK**

5. Move to the **CALL** icon and press **OK** to make the call. The same function can be achieved by pressing the **CALL** key on the remote control.
6. To end the call, use the **DISCONNECT** remote control key; if configured, the system will ask you to confirm disconnection.

To Reselect an Incoming or Outgoing Call

Incoming calls are indicated with a **green** arrow while **outgoing** ones are indicated with a **red** one.

A cyclic buffer of 60 numbers is available to store calls.

To reselect a called number press the **CALL** remote control key twice. A list will appear, and numbers can be selected and modified.

TCS-4 Mode Video Call

The TCS-4 mode is an H.320 call (ISDN) to a gateway which is able to transcode H.320 (ISDN)/H.323 (IP).

The format for number entry is:

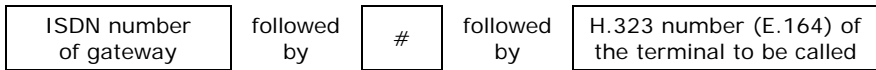

Audio call

If you would like to make an audio-only call (using the System like a normal telephone), select the **AUDIO** icon from the **HOME PAGE**.

To complete the audio call, follow these steps:

- 1) Select the type of call (ISDN, IP-H323, IP-SIP, NIC) from the drop-down menu.
- 2) Enter the number or the alias (IP) you want to call using the keys on the remote control or the virtual keypad.
- 3) Move to the **CALL** icon and press **OK** to make the call, or press the **CALL** remote control key.

To end communication, use the **DISCONNECT** remote control key: if enabled, the system will ask you to confirm disconnection.

Secure Connections

The System can manage secure videoconference sessions via encrypted connections, in both point-to-point and multipoint sessions. To do this, the encryption function must be enabled: for more information, refer to the "Encryption" section of this manual.



Once encryption is properly configured, you can make a secure call by following the same procedure described for a standard call.

Useful information:

The encryption status can be checked on the status bar.

If the encryption is enabled and configured, an icon showing a padlock is displayed on the status bar.

When in a conference call session, the padlock icon meanings are:

	Encryption has been enabled but the function is not active.
	Encryption is active.
	Encryption is activated only in transmission.

How to receive a call

If you are in the **HOME PAGE** and receive a call, a notification will be displayed in a window showing the caller's number. If the automatic answer function (described in a later section) is not enabled, you will be asked whether or not to accept the call. If you are in a different page, you will be asked to accept or reject the call whether or not the automatic answer function is enabled.

Dual Video Mode (option)

Dual Video Connection

You can create a Dual Video connection to send two video streams originating from different sources.



This is feasible on the condition that the remote terminal supports Dual Video. Dual Video transmissions can be initiated by either the Audio-Video calling or called terminal. If the receiving terminal is set up with XGA/DVI-I output, and one of the received streams is an XGA stream, this one will be automatically displayed into XGA/DVI-I output. However, the user is able to switch the automatic disposition by pressing the **C key on the remote control.**

To create a Dual Video connection:

1. Set up a normal audio-video connection with the desired terminal.
2. Press the **Dual** key on the remote control.
3. Select the desired second video input source from the drop-down menu.
4. Move to the **YES** icon and press **OK**.



Once Dual Video is activated, if the receiving terminal is set up with two monitors, the user will be able to see the two video streams simultaneously. If there is only one monitor, the user can switch between the video streams by pressing the **SELF** key on the remote control.

Dual Video Disconnection

To disconnect Dual Video only:

- 1) Press the **Dual** key on the remote control.
- 2) Move to the icon **Yes** and press **OK**.

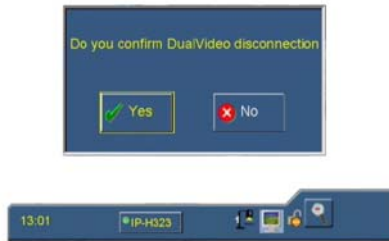

Note

To disconnect the whole Videoconference press the **Disconnect** key on the remote control.

Phonebook

System allows use of either a “local” phonebook or a phone book on a “remote server” (LDAP H.350 protocol).

You can select desired phonebook by means of drop-down menu:

Local	for local phonebook
Remote server identifier	for remote server phonebook

Entering Names in the Phonebook

From the HOME PAGE, go to the **PHONEBOOK** icon and press **OK**, or press the **PHONEBOOK** remote control key.

Move the **arrow** keys to the **Enter** icon and press **OK**.

The following page will be displayed:



Enter data in the phonebook by using the remote control alphanumeric keys or the virtual keypad to fill out the available fields.

- Choose the call configuration to record the connection details for this user (**Type of call** and **transfer rate**)
- Enter **Name** and **Company**:
- Enter the prefix and number **Code/Number**:
- Using the **arrows** move to the **Save** icon to save the new data or to **Cancel** to exit and press **OK**

Note:

If you want to store an audio call only entry, you must check the **Speech box.**

Modifying and Erasing Phonebook Entries

To modify a phonebook entry:

1. Select the desired entry and press **OK**
2. Move to the **Modify** icon and press **OK** again
3. Enter modifications and save them

To erase an entry in the phonebook:

1. Select the desired entry and press **OK**.
2. Move to the **Cancel** icon and press **OK** (the system will ask you to confirm deletion).

Connecting to a global Remote Phonebook

Phone book on a remote server (LDAP H.350 protocol).

To use remote server phonebook, you need to previously configure the remote server (**Server Configuration** icon).

Note

To correctly configure remote server connection parameters, please contact your network administrator.

To connect to the remote server, from **PHONEBOOK** page move to the drop down menu and select the desired server IP address.

To activate the connection select the **Connect** icon and press **OK**.

The phonebook will now operate as described above.

Video Input Management

It is possible to manage different video inputs by selecting them using the remote control keys **Camera**. The function keys **Red – Yellow – Camera**, can be configured to be associated with any available video input. Possible choices include:

- Room camera
- XGA/DVI-I video input
- Whatever video peripheral with composite signal (e.g. camera or VCR)

Note: The desired video source must be connected to the System inputs on the back of the equipment beforehand. For a correct setup of the function keys, see the chapter “Audio-Video-Data”, section “Camera”.

During a connection it is also possible to control not only the local video camera’s zoom and panning functions but also those of the remote camera (if enabled). Use the remote control key **Far/Near** to select remote or local camera.

Field of View and Zoom

You can control field of view and zoom in two ways:

- From the **HOME PAGE**, using the remote control, go to the “video window” and press **OK**. Adjust the video camera’s field of view with the **arrow** keys and press **OK** on the remote control.
- From the **HOME PAGE**, go to the **Magnifier** icon on the status bar and press **OK**. You will see a full screen display with the camera under your control. To release camera control, press **OK**.

Using the XGA/DVI-I IN/OUT

In the system rear panel there are an **XGA/DVI-I** input to connect a personal computer. For a correct cabling, see the “cabling scheme”.

Correct use of the **XGA/DVI-I** implies that the video PC configuration has been set (setting: screen→ properties) with one of the following picture frequency limits (or refresh frequencies).

Resolution	Refresh Frequency (Hz)
640 x 480	60, 70, 72, 75, 85
800 x 600	60, 70, 72, 75, 85
1024 x 768	60, 70, 72, 75, 85
1280 x 1024	60, 70, 75

Video Privacy



In connection

To activate the Video Privacy function, press the **PRIVACY** key on the remote control. Local video will no longer be transmitted.

The icon  will appear in the video window indicating that the remote terminal is no longer receiving video from local terminal.

Not in connection

Activates/Deactivates:

-  – Video privacy as above.
-  – Do Not disturb System does not answer to incoming calls (busy for the remote)

Controlling audio

The **VOLUME** (+ and -) keys allow you to adjust the level of received audio.

By pressing **MUTE** key you can activate the mute function, that is local audio will no

longer be transmitted. On both the local and remote displays, the icon  will appear, indicating that the mute function is active.

Video camera presets

The Preset function allows the user to save camera positions (up to a maximum of 122 positions) in order to enable quick selection of a certain camera frame.

To save a preset:

1. Set the desired camera position and adjust the video zoom.
2. Press the **MEMO** key on the remote control and choose a memory location (maximum two characters)

To recall a memory location:

1. Press the **SEL** remote control key
2. Using the remote control key, enter the memory location number corresponding to the desired preset.

Note: The preset includes both the selected camera and its position, so recalling a preset can change the current video camera. Besides, from remote, the protocol of control of the camera allows to recall only the first 16 memorized presets.

System Configuration - Settings

This section describes the procedures to properly configure the System.

Note that some configuration parameters can be modified only when no connection is active.

User preferences

From the HOME PAGE select:

SETTINGS / USER SETTINGS.

The following page will be displayed:

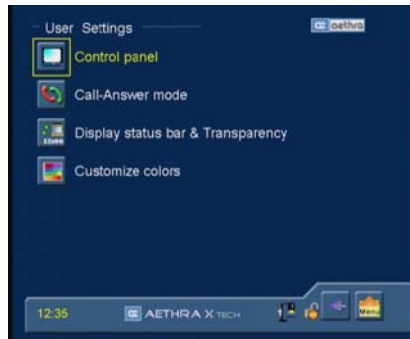

From here you can access the following submenus:

- Control Panel.
- Call-Answer mode.
- Display status bar & Transparency.
- Customize colors.

Control panel

In these pages you can configure some system parameters.

- **General**
- **Screensaver**
- **Remote control**

General

- **Show Local Info:**
If activated, shows information such as terminal name, ISDN number, and IP address on the monitor in graphical form.
- **Show warnings:**
If activated, allows visualization of “Bonding Recovery” messages.
- **Show logo when in a call:**
Enables/disables logo display during a call. Logo is customizable—default is Aethra S.p.A.
- **Disable still picture:**
disable transmission/receiving of “still images”.
- **Send received still to TFTP server:**
Disable or enable and configure TFTP server (to obtain server IP address, please contact your network administrator). If enabled, still images can be sent and stored in a TFTP (Trivial File Transfer Protocol) server. These still images will be available for future use.
- **Enable startup jingle:**
If activated, allow the jingle to every reboot of the system.
- **Show video name:**
If activated, allows visualization of the remote terminal “Name”.

Screensaver

- **Automatic screensaver:**
to enable/disable the automatic screensaver function, and to set its timeout.
- **XGA on screensaver:**
Enable/disable XGA loop function: “XGA IN” signal sent to “XGA OUT.”
Two possible cases:
 - Active “XGA IN” signal: monitor shows XGA signal.
 - Inactive “XGA IN” signal: no signals on monitor (“Stand By” mode).

Remote control

➤ **Numeric only remote control:**

Enable\Disable alphabetical digits only on the remote control.

➤ **ID code (1-99):**

In order to control more systems with only one remote control, you can assign to each system a numeric code (01 to 99), and then consequently set the remote control.

A) To configure the system:

1. Select the code box.
2. Enter the code.
3. Select (with **arrows** on remote control) the  icon.
4. The system will ask for confirmation.
5. If confirmed, a window will appear and ask you to configure the remote control with the new code.
6. Configure the remote control and press **OK**.

B) To configure the remote control:

1. Press the **RED** and **GREEN** keys at the same time.
2. Wait for **Stand by** key stopping blinking.
3. Insert the numeric code (01 to 99)

Note:

codes from 1 to 9 must be composed of two digits (e.g. 03).

Call-Answer mode

General

This menu contains the following configuration settings:

- Mute:
selected, at the start-up and after each disconnection system will not transmit audio, an icon will be displayed in the local and remote terminals.
- Do Not Disturb:
selected, at the start-up and after each disconnection system will not accept incoming calls, an icon will be displayed in the local terminal.
- Video Privacy:
 - Once in connection.
To activate the Video Privacy function, press the video **PRIVACY** key on the remote control. Local video will no longer be transmitted.

The  icon will appear in the video window indicating that the remote terminal is no longer receiving video from local terminal.
 - Not in connection.
Activates/Deactivates:
Video privacy as above.
Do Not disturb System does not answer to incoming calls (busy for the remote).
- Enable Tones:
Enable/disable tones in phase of call.
- Confirm disconnection:
Enable/disable confirmation requests for call disconnection.
- Automatic answer:
Enable/disable the automatic answer function, after the selected number of rings.

H.323

In this menu you can to select the dialing number format mode.

H.320

This menu contains the following configuration settings:

- **Audio Number = Video Number:**
In a non-aggregated ISDN call, the audio number may be different from the video number. If this checkbox is not selected, the System will request the video number and offer by default the same number as the one used by audio.
- **Additional Calls:**
Select automatic or manual configuration of additional calls
- **Mode:**
Allows you to set the call mode to 64K or 56K.
- **TCS4 Delimiter:**
definition of TCS4 calls delimiter: "#" or "*"."
TCS4 is a special routing method for direct video call when a Gateway is present on the network (ISDN network to IP network).
To place a call using a TCS4 extension, do the following:
 1. Obtain the following information:
Gateway number, delimiter and TCS4 extension.
 2. Dial the Gateway number, the delimiter and the TCS4 extension.
Example: .

Broadcast

This menu contains the following configuration settings.

This option allows you to set a transmission as Broadcast (without capabilities exchange).

You will be prompted for a password.

Note:

In order to make a Broadcast call, the two terminals must have the same audio, video, rate and Data (LSD) configurations.

Display Status Bar and Transparency

- **ENABLE STATUS BAR:**

Allows you to personalize the System graphical interface, choosing whether you want the status bar to be present and, if so, what information should be displayed on it.

Status bar information:

Date & Time, Selected camera, Channel status, Charges, and Data channel.

- **TRANSPARENCY:**

Allows you to add transparency to graphical pages where the video window is not reduced in size.

This transparency can be set to four different preset levels (high=75% transparency, medium=50%, low=25%, opaque=0%).

Transparency can be used in different ways:

- a. **Automatic:** (default) Only the diagnostic pages of the "Connection state" use transparency with a selectable initial level (default medium). The transparency level can be changed dynamically.
- b. **Variable:** All pages where no video is present use a selectable initial transparency level (default medium). The transparency level can be changed dynamically.
- c. **Fixed:** All pages where no video is present use a selectable initial transparency level (default medium). The transparency level cannot be changed dynamically.
- d. **Off:** Transparency is always deactivated.

Dynamic change of transparency level is achieved by pressing the remote control key **C**. The transparency is always deactivated when a page is superimposed with a message page to improve legibility.

Customize colors

Customize colors: allows personalization of the graphical interface colours of the System.

Audio – Video – Data

From the HOME PAGE select:

SETTINGS / AUDIO VIDEO DATA

The following page will be displayed:



You can access the following submenus:

- Audio.
- Video Quality.
- Cameras.
- Monitor.
- Data channel.

Audio

You can access the following submenus:

- Inputs
- Processing
- Outputs

and adjust the ringing and sound volume.

Volume for Ringing and Sound.

For adjust the **ringing** and **sound volume**, follow these steps:

1. Select **AUDIO** or **RINGING** from the **Volume** dropdown menu.
2. Use the remote control **arrow** keys to move the Volume slider control.
3. Choose the desired value, using the remote control **arrow** keys.

Inputs

Allows for the adjustment of each audio input to the System.

Move to the desired input and press **OK**, a window will appear where you can:

- Set the **Gain** value for the input
- Enable/disable the input audio stream
- Enable/disable the **Echo Canceller**

Recommended inputs for video or DVD:

We strongly recommend using “**VCR**” inputs for signals directly coming from video-recorders or DVD, because the echo cancellation is disabled on these inputs.

Recommended inputs for external audio Mixers:

We strongly recommend using the “**Line**” input for signals directly coming from an external audio mixer, because echo cancellation can be enabled on this input.

The icon **Load default values** restore factory values of the audio inputs enabling all the audio inputs.

Processing

In this menu you can enable/disable the Echo Canceller functions:

- **AGC**
- **Noise Reduction**

Outputs

In this page you can configure audio flows sent to the System Audio outputs.

You can first select Audio outputs from drop down menu, and then select the audio flow you want to send to the desired output.

To restore factory values click on **Load default values** icon.

Video Quality

From the **HOME PAGE** select:

SETTINGS / AUDIO VIDEO DATA / VIDEO QUALITY.

This allows the configuration of the following parameters:

- **Video Quality-Speed:**
To balance between sharpness and dynamic nature of video images.
- **Aethra Error Strategy:**
Set the number of allowed line errors before video is frozen:
 “Min Fluency”: stop video at the first occurred error,
 “Max Fluency”: never stop video and allow errors through.
- **Audio Delay Automatic:**
You can also **synchronize audio with video**. The audio delay represents the value in milliseconds by which received audio is delayed.
In order to have perfect synchronization between audio and video, it is necessary to adjust these parameters according to the connection type.
By selecting the check box (strongly recommended option), you allow this operation to be performed automatically by the system. Alternatively, you can make manual adjustments by moving the slider along the bar until you obtain the best synchronization.

Cameras

This menu allows you to:

- Settings
- Customize
- Driver

Settings

- Enable/disable the remote control of the local camera.
- Enable/disable the Bring Back to place button of the local camera. The last position of the Main camera, in case of stand-by of the set top, will be memorized for being restored to wake up again.
- Select, from dropdown menu, the video input.
- Set the values for contrast, brightness and colour in order to obtain a better video image. A preview window allows the immediate control of changes.
- Auto Adjust button
Autolris setup of the Main camera.

Customize

Each input could be enabled\disabled (that is, inserted in a selection list), associated to a Name, associated to a shortcut (RED, YELLOW, Camera keys on remote control) for a quick choice.

To choose a shortcut, select the related icon and press OK.

For the XGA/DVI-I input from the dropdown menu you can chose:

- Analogical (analogical DVI signal input enable)
- Digital (digital DVI signal input enable)
- Automatic (default; analogical and digital DVI signal input enable)

(For XGA/DVI-I input, see cabling scheme)

Note:

DVI-I interface includes digital and analog signals (VGA, XGA, etc.)

Driver

Advanced (Administrator Password Required)

Select driver for Room Camera and other Video Input, and enable the PTZ function (check MOVE) for all video inputs.

Monitors

In this page is possible to configure system video outputs.

You can access three menus:

- Settings
- PIP-PaP
- Plasma/Lcd

Settings

In this page you can set following system parameters:

- Monitors Number
 - Monitor Menu
 - Video outputs
- Dropdown Menu Monitors Number (default setting: Automatic).
 Following table shows all available configurations:

<u>Dropdown menu</u> <u>Monitors Number</u>	Connected monitors
<u>Automatic</u>	System automatically recognizes connected monitors
<u>TV1</u>	One analogical monitor.
<u>HDTV</u>	One XGA/DVI-I monitor.
<u>TV1 + TV2</u>	Two analogical monitors.
<u>TV1 + HDTV</u>	One analogical monitor and one XGA/DVI-I monitor.
<u>HDTV + HDTV AUX</u>	Two XGA/DVI-I monitors.
<u>TV1 + TV2 + HDTV</u>	Two analogical monitors and one XGA/DVI-I monitor.
<u>TV1 + HDTV + HDTV AUX</u>	One analogical monitor and two XGA/DVI-I monitors.
<u>HDTV + TV1</u>	One XGA/DVI-I monitor and one analogical monitor.
<u>HDTV + HDTV AUX</u>	Two XGA/DVI-I monitors.
<u>HDTV + HDTV AUX + TV1</u>	Two XGA/DVI-I monitors and one analogical monitor.

➤ **Dropdown Menu Monitor Menu:** (default setting: Automatic).



In case the **TV1 + HighDefTV:** configuration has been chosen, so to have two monitors connected to the system, is possible to choose where to see GUI (Graphical user interface). Available configurations are:

Automatic:	GUI set by the system
TV1:	GUI always on TV1
TV2:	GUI always on TV2
HDTV:	GUI always on XGA/DVI-I
HDTV AUX:	GUI always on XGA/DVI-I

➤ **Video outputs**

Referring to the selected (or automatically recognized by the system) **Monitors number:** in the lower area of the page the active video outputs are highlighted, and you can select:

- **16:9:** check box,
- XGA/DVI **resolution:**
- **DigitalDVI:** check box (for High Definition monitors only).

TV1: connect a monitor or an analogical TV to TV1 video output (point ② of “Cabling Scheme” - RCA or Y/C connector, symbol  or ).
16:9: **check box** (use only with 16:9 monitors). If you select **16:9 check box**, the system adds vertical side banners in order to scale full screen video image from 4:3 to 16:9.

TV2: connect a monitor or an analogical TV to TV1 video output (point ② of “Cabling Scheme” - Y/C connector, symbol ).
16:9: **check box** (use only with 16:9 monitors). If you select **16:9 check box**, the system adds vertical side banners in order to scale full screen video image from 4:3 to 16:9.

HDTV: : connect a monitor with a DVI-I connector to XGA/DVI-I video output, or a monitor with a XGA connector through DVI-I/XGA adapter (“OUTPUT” DVI-I connector, see “Cabling Scheme”) use in dropdown menu the correct Resolution for used monitor.
16:9: **check box** (use only with 16:9 monitors). If you select **16:9 check box**, the system adds vertical side banners in order to scale fullscreen video image from 4:3 to 16:9.
 If you use a High-Definition digital monitor you have to select **Digital DVI:** **check box**.

Available XGA/DVI-I output resolutions are:

XGA resolutions
1280x768
1024x768
800x600
640x480

HDTV resolutions
720p
576p
480p

Note:

DVI-I interface includes digital and analog signals (VGA, XGA, etc.)

The following example show the adjustment of 4:3 video in 16:9 video.



PIP-PaP

In this page is possible to select **"Multi Imagine"** system functionalities:

A) PIP: Picture In Picture

Allows to see two overlapped images in one monitor, that is remote image in full-screen format, an local image in a smaller overlapped window.



By means of remote control **Self** key you can switch windows content.

Is possible to choose:

- **PIP position:** (one of four monitor corners)
- **PIP movements:** (clockwise or counterclockwise) by means of remote control **PIP** key.

B) PaP: Picture and Picture

Allows to see in one monitor two windows side by side, with local and remote images.



By means of remote control **Self** key you can switch windows content.

➤ **Multi Image Type:**

- a. By selecting **AUTO** a mixed PIP and PaP function is enabled. By means of remote control "PIP" key you can switch between PIP and PaP.
- b. By selecting **PIP**, PIP function is enabled.
- c. By selecting **PaP**, PaP function is enabled.



Multi image type must be enabled separately for TV and HighDefTV monitor.

➤ **Multi Image Mode:**

- a. By selecting **AUTO** PIP and PaP functions are enabled only when needed, that is when number of video flows is greater than available monitors number, and automatically place video flows (with precedence to remote ones).
- b. By selecting **ON** PIP and PaP functions are enabled if at least two video flows are available (in case of unique video flow you have a full screen image, e.g. when system is not connected)
- c. By selecting **OFF** PIP and PaP functions are disabled.



Multi image mode must be enabled separately for TV and HighDefTV monitor.

➤ **Multi Image: remote control Self key and monitor info.**

Remote control **Self** key allows to show video flows in different available monitors, choosing among different combinations.

In the lower right corner of monitor containing GUI, an icon appears with four white monitors showing available configurations, active configuration being in red.

The icon is hidden when default configuration is active.

Plasma/LCD

Select plasma, type of monitor and viewing modality.

Note: The follows instructions refers to “Pioneer” monitors.



Please carefully check XGA, Y/C and RS232C/DEBUG (null modem cable) connections between plasma and System.

- a) In the **Type** field, set the plasma model
- b) In the **Number of monitors** field, select the number of connected plasma monitors
- c) In the **Mode** field, select the default viewing mode from the pop-up menu.



First time “Plasma type” is selected (usually factory done), a particular operations sequence must be followed:

1. **Do not connect the system and the monitor by means of serial cable.**
2. **Select plasma type.**
3. **Once completed all initializations, switch off the system, connect the system and the monitor by means of serial cable, switch on the system: now is ready.**

Viewing modes

Different viewing modes may change depending on used monitor characteristics . Following viewing modes with corresponding short explanations refer to Pioneer systems.

- A) **Automatic MultiScreen.**
- B) **Fixed MultiScreen.**
- C) **Automatic BigLittleScreen.**

A) **Automatic MultiScreen:**

Selecting this mode, the system shows two side-by-side equal-sized pictures: graphics relating to system management will appear on the right, whereas motion video will appear on the left.

Once connected, an XGA remote signal automatically changes the viewing mode to BigLittleScreen mode; once in this mode, surfing inside menus will let back again to the MultiScreen viewing mode.

To see a local XGA image select full-screen visualization, then you can switch to BigLittleScreen mode by pressing the **C** key on the remote control.

Exiting from the FullScreen mode, the system immediately comes back to the MultiScreen viewing mode.

a) Disconnected system.



b) Connected system (with 50" Pioneer plasma, you'll obtain two 27" images, 4:3).



c) Connected system that receives a remote XGA image (with 50" Pioneer plasma, you'll obtain two 4:3 images, a big one (42") with 1024 x 768 XGA resolution image and a small one (11").

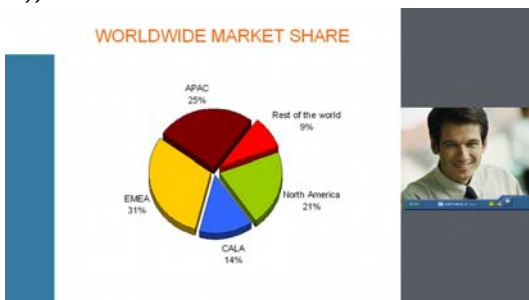

d) Connected system with remote XGA image, while local user looks at the menu.



e) Connected system with remote XGA image, in DualVideo XGA mode. The larger pane displays the XGA image, while the smaller one displays the remote vide stream.

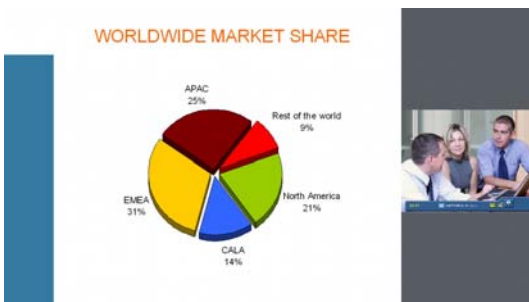

B) Fixed MultiScreen:

Selecting this mode causes the system to display two side-by-side, equally-sized frames. Graphics relating to system management will appear on the right, while remote video (or XGA) appears on the left.



C) Automatic BigLittleScreen:

If this mode is selected, the system will show two video outputs in different-sized frames. The larger frame on the left will show the graphics relating to system management, while the video stream will appear in the smaller frame on the right.

During an active connection, the system automatically selects which video stream to place in the larger frame. The initial viewing mode can be restored only via the menu.

a) Disconnected system.



b) Connected system.



c) Connected system that receives an XGA image.



d) Connected system while user browses the menu.



e) Connected system that receive an XGA image on Dual Video XGA mode.



Data Channels

From the **HOME PAGE** select:

SETTINGS / AUDIO-VIDEO-DATA / DATA CHANNELS

In this menu you can:

- Enable or disable **Data** transmission.
- Select the **Serial Rate**.
- Enable or disable **Modem** function (if activated allows AT commands usage).
 - Activate/deactivate the **RS232 control**.
- Choose the **max data channel rate** (H.320 only).

High	Max data, no audio, no video. Data channel optimization to the detriment of both audio and video
Medium	Max data, audio, no video. Data channel optimization to the detriment of audio (video still active)
Norm	Max data, audio, video. Data channel optimization, with both audio and video active.
Auto	Data, audio, video. Data channel rate optimization to RS232 rate and connection speed.
Select Rate	User can choose the data channel rate.

- Choose **MLP** data transfer protocol

Installation

From the **HOME PAGE** select:

SETTINGS / INSTALLATION

You will be prompted for a password.

The password is required to avoid accidental modifications and changes to settings.

Terminal Settings

From the **HOME PAGE** select:

SETTINGS / INSTALLATION / TERMINAL SETTINGS

In this section you can configure terminal settings for various network interfaces.

For each interface it is possible to set, if present:

- The maximum data Rate for a call (excluding NIC).
- Audio coding.
- Video coding.
- Bonding.

Determine if channels are to be bonded or not (ISDN only).

Note: With audio and video encoder/decoder settings set to <Auto> the system choose the encoder/decoder based on the connection bit rate.

Moreover you can explicitly enable/disable some functionalities, in order to have the system being compatible with old systems.

Network interfaces

From the **HOME PAGE** select:

SETTINGS / INSTALLATION / NETWORK INTERFACES

In this section you can choose and configure the system's network interfaces. For each interface, it is possible to set some parameters.

IP configuration

From the **HOME PAGE** select:

SETTINGS / INSTALLATION / NETWORK INTERFACES / IP

The following page will be displayed:



The five available options are:

- IP Configuration
- H.323 settings
- SIP settings
- Services
- PPPoE

IP Configuration

This menu is for Integrated LAN configurations; select **IP Configuration** and select the type of the desired LAN Network:

- Select **IP Configuration** (Integrated LAN)
- Select **IP Wireless Configuration** (Wireless LAN)
- Select the **Priority** between **Fixed Network** and **Wireless Network**, for outgoing calls.

IP Configuration (Integrated LAN)

In this menu, you can enable/disable automatic assignment of an IP address:

- IP address;
- Subnet mask;
- Gateway IP address;
- DNS server IP address.

Is possible to configure Ethernet port either for what concerns connection LAN speed (10Mbps / 100Mbps), or Duplex Mode (Half / Full), in order to optimally operate with HUB/Switch that do not support automatic configuration. Default configuration is <Auto> for both settings.



For configuration information, please contact your network administrator.

- By selecting **Advanced**, you can enter a page to set:
 - A) The range of **Dynamic Ports** of TCP and UDP (*).
 - B) Use **NAT**:
 - a) **NAT Type** should be set to "Others"
 - b) **Public IP address** must be the public IP address of the NAT
 - C) The **Quality of service** policy to be applied:
 - a) IP Precedence/TOS
 - b) **Differentiated service**. You can choose audio and video values in a 0 to 63 range
- By selecting the **BANDWIDTH** icon is possible to enable and set maximum bandwidth usage limits (in Kbps). These limits can be different in transmission and reception, a very useful function on ADSL networks.

Firewalls

All Aethra videoconference systems have been tested with:

Cisco PIX Firewall (Firewall H.323 compatible - release 6.1 or later).

Cisco MCM Proxy (NAT H.323 compatible - IOS release 12.2 or later).

Note (*)

When a firewall is crossed, the firewall administrator must open a range of dynamic TCP and UDP ports, as configured in the system, to allow bidirectional IP traffic. Moreover, once the ports have been opened, the protocols (TCP 1720 (Q.931), TCP 1503 (T.120), UDP 1719, and 1718 (RAS)) involved in a call must be taken into account.

IP configuration “Wireless” (Optional)

In this menu, you can enable automatic IP configuration, or enter the following data manually:

- **IP address:**
- **Subnet mask:**
- **Gateway IP address:**
- **DNS server IP address:** corresponding to a wireless network.



For configuration information, please contact your network administrator.

By selecting **Advanced:**, you can enter a page to set:

- **SSID:** wireless network identification.
- **MODE:**
 - Ad-Hoc:** all terminals in the network communicate with each other, and not with a dedicated access point.
 - Managed:** all terminals present in the network communicate with an access point.
- **ENCRYPTION MODE:** enable/disable encryption and allow user to set the desired key length.
- **ACTIVE KEY:** select one of four alternative keys.

By selecting the **BANDWIDTH:** icon it is possible to enable and set maximum bandwidth usage limits (in Kbps). These limits can be different for transmission and reception, a very useful feature on ADSL networks.

Note: This manual contains a section on “Recommended Wireless Network Interface Cards”.

H323 Settings

This section contains the configuration options necessary to use the system with the H.323 protocol:

- **Name H.323:** (H.323 ID) the name used by the terminal for registration with the gatekeeper.
- **Number H.323:** (E.164) identifying number used by the terminal for registration with the gatekeeper
- **Gatekeeper:** use and address
 - Gatekeeper **automatic IP address**
 - Gatekeeper **static IP address**
 - Advanced:** **Automatic registration** to Gatekeeper, allows the user to change registration timings
- **Using NetMeeting:** If a T.120 connection is available, a data conference using NetMeeting can be started by entering the IP address of the application host server. To enable this function:
 - Check the box next to **Use NetMeeting**
 - Enter a server **IP address** where the application is hosted.



For configuration information, please contact your network administrator.

SIP Settings

This section contains the configuration options for use of the system with the SIP protocol:

- **Terminal Name**
- **Terminal Password**
- **Use registrar:** run terminal registration at a SIP Registrar Server.
 - Server:** Enter SIP Registrar Server IP address.
- **Use Proxy:** use a Sip Proxy Server.
 - Server:** Enter Sip Proxy Server IP address.
- **TCP - UDP:** use the appropriate protocol.
- **Port:** Port for server signaling (Default is 5060).



For configuration information, please contact your network administrator.

Services (Web-Telnet, SNMP, Streaming)

The System allows for the configuration of various parameters associated with web management, SNMP management and streaming management.

A) Web-Telnet management

In this section you can:

- a) Enable/disable System access from the Web using Telnet by means of IP, ISDN connections.
- b) Enable/disable phonebook management from the Web.
- c) Enable/disable phonebook management from the Web via ISDN (default: enabled).
- d) Limit access to a single IP address or any IP address in a specified network.
- e) Change the Web/Telnet access password (default: Username Aethra, Password 1234).
- f) Enable/disable https service, that is the "Secure Socket Layer" function.

B) SNMP Management

In this section you can:

- a) Enable/disable SNMP use.
- b) Enter Administrator name.
- c) Enter Location.
- d) Limit editing of settings to one IP address, or any IP address on a specified network.
- e) Limit reading of settings to one IP address, or any IP address on a specified network.



For configuration information, please contact your network administrator.

C) Streaming Management

In this menu the System can be configured to use streaming. This technology allows viewing of and listening to live or recorded events by a large number of users connected to the IP network without the need for a large file to be downloaded. It is based on the continuous transmission of data compressed by particular programs (systems) from a server, then decoded at the client side by an appropriate player that works even during data buffering, thereby avoiding long delays.

The System is able to transmit to networks in either unicast or multicast. If the streaming is unicast, only one client at a time is allowed to connect to the stream. If it is multicast, there is no theoretical limit to the number of connected clients.

In case of pre-recorded event streaming, replay a recording of the event using a VCR or DVD player connected to the System video input available for this purpose, select this input and begin the streaming.

Note that the system does not act as a distribution server, rather as a simple system. It does not provide connections using RTSP (Real Time Streaming Protocol), nor can it provide unicast streaming to multiple clients, or offer other services typical of distribution servers.

Streaming is supported by RTP (Real-time Transport Protocol). Video packets are encoded in H.261, while audio packets are encoded in G.711.

Menu options are **Streaming Management**, **Enable Streaming** and **Activation**.

a) **Streaming Management**

This option permits that the parameters **Announcements**, **Video**, **Rate**, **Address**, **Port** and **TTL** can be modified by an external application (e.g. from the Web).

If this option is not selected and a unicast IP address is present in the Address, then only the system identified by that IP address would be able to view the stream.

- **Enable/Disable Enable all addresses**:
If enabled allows the above parameters modification from every external system.
- If not enabled, you can define which system or sub-network is enabled to perform such an operation.
If in the **Address mask** the value is 255.255.255.255, a system is selected; if the value is 255.255.255.0 the sub-network is selected.
Likewise, if in the **Address** field a unicast type IP address has been set up, the limitation also effects the visualization of the streaming.
- **Password**: allows password protection of streaming management

b) **Enable Streaming**

This option permits the parameters **Announcements**, **Video**, **Rate**, **Address**, **Port** and **TTL** to be changed.

Allows stream viewing according to the limitations imposed by the parameters "Streaming Management" and "Enable all addresses." If this option is not selected, streaming will never be activated.

Announcements: This drop-down menu allows you to choose how the System will notify the user that an external system has requested streaming activation.

Options:

- **Activation**: The System will display a dialogue box containing a warning and a video camera icon that will stay in place as a reminder for as long as streaming is active.
- **Status**: Only the video camera icon will be displayed during streaming.
- **Confirmation request**: A dialogue box will appear to request confirmation of streaming activation. This option offers an extra level of protection.

Video: This drop-down menu allows you to choose which video signal is transmitted when streaming is active.

If the **Automatic** option is selected, the streaming content will be determined by the status of the terminal: if the terminal is connected (in either a point-to-point or multipoint session), video coming from the remote site will be streamed. If the terminal is disconnected, local video will be streamed.

If the **Local** option is selected, the system will always stream local video.

Rate. This drop-down menu allows you to choose the bandwidth occupied by audio and video streaming. Note that if a rate of 64K has been selected, the video will not be transmitted, because all the bandwidth will be occupied by audio.

Address. This parameter contains the IP address for the stream. If this field contains a unicast IP address, it will be automatically overwritten by the IP address of the system that has requested to view the stream from an HTML page supplied by an internal web server. By pressing the **Active** key on the configuration page, you can activate streaming: the system will start the transmission of audio and video packets to the selected IP address.

If the IP address is multicast, streaming will be sent to a multicast group identified directly by the IP address, enabling viewing by a large number of users (theoretically unlimited).

Port. This parameter contains the number of the UDP port where audio packets are to be sent. Since the streaming content is RTP, data are sent to four different ports: one port for audio, one port for video and two ports for the RTP information corresponding to both streams. Therefore, starting with an audio port number, it is implied that the audio data will be sent to this port number, video data will be sent to the audio port number plus two, and the odd port numbers before and after the video port will be used for RTP data. For example, if the audio port number is 554, the port number for video will be 556, and the port numbers for RTP data on both streams will be 555 and 557.

TTL/Hops. This parameter contains the value for the Time to Live associated with multicast packets.

- c) **Activate:**
Streaming activation/deactivation request.

Viewing methods

Viewing with a plug-in

The integrated Web Server provides the simplest method.

Connect to the System via the Web and from the server homepage click on the image that looks like video—this will give you access to the page produced by streaming. This page has been designed to use Quick Time, which must have been previously installed to view the video stream. Accessing the page automatically activates audio-video streaming. The user can choose the video signal to be displayed (Local or Automatic), which must be compatible with configured settings. The System provides a direct link to streaming page, using the address: <http://aaa.bbb.ccc.ddd/streamviewen.asp>, where aaa.bbb.ccc.ddd is the IP address of the System.

Viewing using an external player

Another way of viewing streaming is to use an external player. The only tested players are QuickTime 6.0 and VIC (supplied by the University of California Berkeley), but this does not exclude the possibility of compatibility with other players that accept RTP streams.

The first operation necessary is to activate streaming. This can be achieved by simply entering the IP address of the system in the "Address" field on the streaming configuration page of the system where the player is located, or the multicast address of the group to whom the stream is being sent. Pressing the Activate key will enable the machine to begin the transmission of audio-video packets to the player.

If you use QuickTime as a player, you can simply select "File" from the menu, then "Open URL in new player" and enter <http://aaa.bbb.ccc.ddd/stream.sdp> where aaa.bbb.ccc.ddd is the IP address of the System that is to send the stream.

Viewing using a Distribution Server

Distribution servers offer a range of services for stream management that the System cannot offer directly. If users would like to make use of a distribution server for streaming transmission sent from a System, they can do so in accordance with the server's characteristics.

Using a Proxy

Multicast streaming transmissions require an appropriate network configuration, with limitations imposed by the presence of any Firewall or Proxy. To offer good protection, these must block IP packets directed to unknown ports, such as the UDP ports used for audio and video streams. If the stream has to pass through such equipment, the equipment must be configured for any eventual multicast and have the appropriate ports enabled for streaming.

If the stream is sent over an internal network, problems can still arise if it is necessary to pass through a firewall in order to gain external access.

Deactivate Streaming

In order to stop streaming, go to the Deactivate key on the streaming configuration page and press **OK**, or simply close the browser.

PPPoE

(Point-to-Point Protocol over Ethernet)

PPPoE is used to allow Internet Service Providers (ISPs) to use their existing Radius (*) authentication systems from dialup services on broadband/Ethernet-based services.

Automatic IP address: If selected, an automatic IP address will be assigned.

- **IP address:** Enter static IP address provided by the ISP
- **Subnet Mask:** Enter subnet mask provided by the ISP.
- **DNS Server IP address:** Enter DNS server address provided by the ISP.

Advanced

This section contains configuration parameters, assigned by the ISP.

Once **PPPoE active** is selected, enter following data:

- **User name:** user name assigned by the ISP.
- **Password:** password assigned by the ISP.
- **Server name:** ISP server name.
- **Service Name:** Default (field empty).
Alphanumeric string for remote control of equipment connected with PPPoE server (ex. modem).
- **Connection mode:**
Two different WAN connection modes are available:
 - Always connected
 - On call

Bandwidth

By selecting the **BANDWIDTH** icon, it is possible to enable and set maximum bandwidth usage limits (in Kbps). These limits can be different in transmission and reception, a very useful function for ADSL networks.

On the PPPoE configuration page there is a **PPPoE status LED**:

White: service not enabled

Red: service enabled, but not active

Green: service enabled and active

* Radius: Remote Authentication Dial-In User Service

ISDN network interface (option)

In this section you can:

- Activate/deactivate:
 - **CLIR** (Calling Line Identity Restriction): if enabled, system will not transmit its number when establishing a call.
 - **COLR** (Connected Line Identity Restriction): if enabled, system will not transmit its number while receiving a call.
- Activate or deactivate the **Downspeed** function that is automatically called when one or more lines are dropped during a call.
- Activate the **FALLBACK** function in order to allow a phone call when the remote system is a basic telephone.
- Enable/disable the **Bonding Recovery** function in order to cope with a situation in which network errors (such as network SLIP errors) occur during a bonding connection.
 - In a call, following messages could appear:
 - *Corrupted video received. Please wait...*
 - *Video received Ok.*
 - *Corrupted data received. Please wait...*
 - *Data received Ok.*
 - *Network error recovery: re-establishing call...*
 - *Call established. Please wait...*
 - *Down-speed, connection rate.*
- Select the **Euro** or **National** Network.
 - Activate or deactivate the **5ESS** protocol (for **National ISDN** only).
 - Select the **64K** or **56K** mode ((for **National ISDN** only).).
 - Activate or deactivate the **1TR6** function (for **Euro ISDN** only, allows you to change the protocol level 3 from ETS1 to 1TR6).
 - Activate or deactivate the **QSIG** protocol (for **Euro ISDN** only, ISDN signaling protocol).
- In the **Access Configuration** section select **BRI** or **PRI** and configure all the ISDN lines you need.

It is advisable to disable any unused ISDN lines.
Changing from one kind of network to the another will require a system restart.

Access Configuration – ISDN BRI Euro

Select the icon with the number of the access to configure and press **OK**.

From this menu, you can:

- Choose to **Enable Accesses**.
- Specify the **Number** to be associated with the access.
- Specify the **Subaddress**, if present.
- Choose to enable the **Multinumber** function by checking the appropriate box.
- Select **TEI**, either Automatic (default) or Fixed.

The TEI is an identifying number that allows the ISDN exchange to distinguish between different terminals connected to a common access point. If TEI Fixed is selected, then you must manually enter the TEI number. Conversely, by not selecting it, the parameter will be set as TEI Automatic. In this case, the TEI number will be automatically assigned by the exchange and no further operations in this menu are necessary.

Note:

Normally, the TEI is left as AUTO because an incorrect setting could create connection problems

Access configuration – ISDN BRI National

Select the icon with the number of the access to configure and press **OK**.

From this menu you can:

- Choose to **Enable Accesses**.
- Specify the **Number** to be associated with the access.
- Specify the **SPID**, if present.
- Select **TEI**, either Automatic (default) or Fixed.
- Enable any eventual **SPID2** and enter the appropriate numbers.

Access configuration – ISDN PRI Euro

This interface can be used by means of the “XLNA” external module (see “X LINE NETWORK ADAPTER” §).

- A) Move to the desired access configuration (icon ) and press **OK**.

In this page you can:

- Choose to **Enable Accesses**.
- Specify the **Number** to be associated with the Primary Rate Interface.
- Specify the **Subaddress**, if present.
- Choose to enable the **Multinumber** function by checking the appropriate box.

- B) Move to the **Advanced** icon, and press **OK**.

In this page you can:

- Choose **Enable CRC4** depending on the connected network.
- **B-channel selection** (Time slot)
 - Choose **Terminal** to select the channel in use for a call or let **Network** to choose.
 - For request from **Terminal**:
 - > Choose **Channel** interval to be used for a connection. You can select an interval by defining **First** and **Last** channel.
 - > **Channel search from** starting from **First** or **Last** defined B channels.

Note: It is appropriate here to stress that unless you have special needs, it is advisable to leave the “network” option selected, since incorrect configuration could create connection problems. For special configurations, please contact your service provider.

Access configuration – ISDN PRI National

This interface can be used by means of the “XLNA” external module (see “X LINE NETWORK ADAPTER” §).

A) Move to the desired access configuration (icon ) and press **OK**.

In this menu you can:

- Choose to **Enable Accesses**.
- Specify the **Number** to be associated with the Primary Rate Interface.
- Specify the **SPID**, if present.

B) Move to the **Advanced** icon and press **OK**.

In this menu you can:

- **B-channel selection** (Time slot)
 - Choose **Terminal** to select the channel in use for a call or let **Network** to choose.
 - For request from **Terminal**:
 - > Choose **Channel** interval to be used for a connection. You can select an interval by defining **First** and **Last** channel.
 - > **Channel search from** starting from **First** or **Last** defined B channels
 - Select **Cable length**. From the drop-down menu, you can also select the length of the cable connecting the System to the Primary Rate access socket used.

Note: It is appropriate here to stress that unless you have special needs, it is advisable to leave the “network” option selected, since incorrect configuration could create connection problems. For special configurations, contact your service provider.

NIC network interface (option)

This interface can be used by means of the “XLNA” external module (see “X LINE NETWORK ADAPTER” §).

G.703 interface configuration (option whit license)

In order to use G.703, it is necessary to have a licence (see section on licensing for more information).

In this menu you can:

- Choose either the **E1** or **T1** protocol
If the system has already been configured to support a PRI interface (either Euro or National), the E1/T1 option is not available and the system is automatically set to the appropriate mode:
 - **Euro Primary Access → G.703 E1**;
 - **National Primary Access → G.703 T1**.
- Choose the **Rate**.
- Set the **Network** speed (**64K** or **56K**).
- Enable/Disable **Automatic call**.
To make an automatic call:
 1. Enter Audio-Video call page.
 2. Select **NIC** in **Type of call** drop-down menu.
 3. Wait for few seconds, and the System will automatically start the call.
- Enable/Disable **Use Ch16**.
- Enable/Disable **CRC4** (E1 only).
- Enable/Disable the **Enabled Alarms** option.
- Configure the System to be either **Master** or **Slave** in calls.
- **G.703 advanced** settings (T1 only).
Select **Cable length** from the drop-down menu, you can select the length of the G.703 cable.

Note:

If the system is configured with PRI lines, Euro or National, the System automatically selects the net in the following way:

Primary Rate Euro Access → G.703 E1;

Primary Rate National Access → G.703 T1.

Note:

If “Automatic call” option is enabled, System will start the call as soon as it notices the presence of a line.

NIC (V.35/RS449/RS530/X21) Interface Configuration (Licence Required—see “Licences” for more information)

This section allows you to customize the NIC interface. The network type (X.21, V.35, RS449, RS530) is automatically recognized by the system.

Available options:

- Select the maximum **Rate** from the drop-down menu.
- Select **Automatic Call** to make the call if network alarms are not present.
- Select **Use RS366** to allow the use of the RS366 interface (leased interfaces are not switched, but they will be switched when combined with RS366).

Select **RS366 Advanced** in the NIC menu to configure some signals:

ON indicates that the signal is managed.

OFF indicates that the signal is not managed.

- Select **Termination** to insert terminations on the interface signals.
- Select **CLOCK RX=TX** for identical bit rates in transmission and reception.
- Select **Terminal Timing** to transmit data with System clock.
- Select **Advanced** in order to display the following advanced settings:

ON indicates that the signal is managed (**OFF** indicates that the signal is not managed).

For all signals: **ON** indicates normal management of the signal, while **OFF** sets the value of the signal to **active**.

Selecting **ON/OFF/ON** in the **DTR** box activates the **Resync pulse**.

Selecting **RING** in the **CD** box indicates the signal is used for announcing an incoming call.

Note:

To use the NIC interface licence is needed, as well as a cable corresponding to the desired interface.

Enable network

It is possible to enable/disable any calling protocol.

Once explicitly disabled, a protocol will no longer appear in the “combo-box” for call selection.

An incoming call will be always accepted, even if the incoming protocol is disabled.

Location

From the **HOME PAGE** select:

SETTINGS / INSTALLATION / LOCATION.

The following page will be displayed:



This section contains regional data about the terminal:

Terminal Name: Enter a name for the terminal

Country Name: Select the country. An international country code will be automatically provided.

Language: Select the desired language.

PBX: Enter the PBX access number for an outgoing call.

Audio Coding: Select the type of audio encoding in "Transmission."

Video Standard: Select the video standard (PAL/NTSC), depending on the peripheral connected to Video Out.

Selection Tone: Select the desired tone.

Camera Frequency: <Auto> or 50Hz (NTSC).

Date and time settings

By means of **arrow** keys select time on the control bar, and press **OK**: insert date and time.

Load default settings

From the **HOME PAGE** select:

SETTINGS / INSTALLATION

From here, the default System configuration can be reloaded. There are two options:

- User settings only
- Factory Defaults

Once selected the desired option from the dropdown menu, move to the LOAD
DEFAULT VALUES icon and press **OK**. Read all instructions carefully.

If the FACTORY SETTINGS option has been chosen, users will be asked, as a precaution, for confirmation. An affirmative answer will result in the factory settings being reloaded. All user settings and data will be lost, including call history, phonebook numbers and static IP addresses.

Licenses

From the **HOME PAGE** select:

SETTINGS / INSTALLATION / LICENSES

This page is dedicated to supplementary functions not offered by default. In order to obtain information on the activation of these functions, please contact your system supplier.

To insert a licence key by means of the remote control:

1. Enter the licence key.
2. Press the Enable Licence icon.

Available options, under licence:

- a. **Up to 4Mbps IP connections**
- b. **Up to 768Kbps ISDN connections**
- c. **PRI connections**
- d. **NIC (X.21, V.35, RS.449, RS.530, RS.366) connections**
- e. **G.703 connections**
- f. **MCU**
- g. **Dual Video**

Encryption

From the **HOME PAGE** select:

SETTINGS / INSTALLATION / ENCRYPTION

The configuration menu will be displayed; here you can set the following parameters:

Enable Encryption:

If encryption is activated, the System will use encryption in either H.323 or H.320. It is also possible to enable/disable the encryption from the toolbar: select the padlock icon, and press **OK**.

For IP calls:

- If encryption has been activated, the data protection procedure is active from the beginning of a videoconference.

Encryption is active from start (ISDN):

- If this option is selected, the System executes the encryption procedure from the beginning of the ISDN connection.
- If this option is not selected, the ISDN connection starts in unencrypted mode. Encryption can be activated later at any time during the connection. To do this, select the yellow padlock on the status bar and press **OK**.

Unprotected calls:

From this drop-down menu you can choose the policy the System will apply if the remote terminal is not able to support protected calls.

- **Disconnect** – The System will not allow connection with a remote terminal that does not support encryption, and therefore automatically disconnects.
- **Ask Confirmation** – During the session negotiation phase, the System will ask you to confirm that you want to establish an unprotected call.
- **Inform** – The System will inform you that you are about to establish an unprotected connection by displaying a visual warning message.
- **State** – The System will notify you that you are about to establish an unprotected call, and once the connection is established an open padlock symbol will be displayed on the status bar.

Length of AES Key: (ISDN only)

From this drop-down menu you can choose (for ISDN connections only) three AES key lengths:

- 128 bits
- 192 bits
- 256 bits
- **<Auto>** (allows optimal choice according to the characteristics of the terminals negotiating the videoconference session.)

Note

For an IP connection, the key length is always 128 bits.

Length of Prime DH Number: (ISDN Only)

The encryption protocol requires the simultaneous exchange of a prime number and an AES private key between terminals.

For H.320 calls you can choose between two prime number lengths:

- High Security (length 1024 bits)
- Very High Security (length 1536 bits)

Note

For IP calls, the System always uses the High Security option with a 1024-bit length. Most common video communication terminals normally use the High Security prime number length and the 128-bit AES private key.

Password

There are three different kinds of passwords:

Administrator password: Always active. Can be modified by pressing the  icon.

User password: Must be activated. Can be modified by pressing the  icon. You can access **SETTINGS** page only.

Phonebook password: Must be activated. Can be modified by pressing the  icon.

Note: The Default password value is “1234”.

Presentations

During a call, the system allows to send slides or still images in Jpeg format that have been previously loaded on the system using a PC.

- To load files onto the system, a PC with the AePPTManager program installed must be used. The program can be downloaded by entering the System WEB interface and selecting the **TOOLS** icon.
 1. Download the AePPTManager.exe software
 2. Start AePPTManager.exe
 3. For a correct operation, files must be extract to a PC folder.
 4. The self-extracting file includes AePPTManager.exe and AePPTManager.ini.
- Executing the program will display the following:

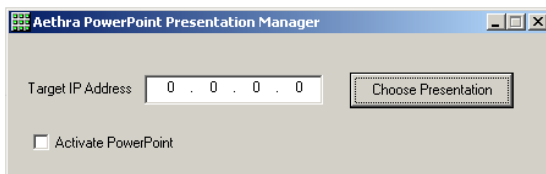



1. The program requests you to enter the system's IP address and to choose the presentation to transfer.
2. By pressing the **SLIDE** key on the remote control, you will enter the presentation manager page.



3. Selecting the **DISPLAY PRESENTATIONS** icon and pressing **OK** will cause the first nine slides of the presentation being displayed on video.
4. You can select a slide by moving the remote control **arrows** and pressing **OK**. The slide will be locally displayed at full-screen and sent to the remote system.

5. The presentation can be managed using the remote control **arrows** or using the icons that appear in the lower area of the screen.

	Go back to previous slide.
	Go to next slide.
	Show slides sequence.

To leave the presentation, press the **HOME** key on the remote control.

Slides storage

During a call, the system automatically stores slides or Jpeg images received from the remote system. Up to 50 images will be stored in a circular buffer, till the connection is terminated.

Slides recall via WEB client

Enter the System WEB interface, select **Camera and Video Control** and in the dialog box labeled **Photo** click **Photo Download**.

A list will be opened, containing slides named SnapshotXX.jpg.

Saving slides on a PC

When a file is selected, the image will be uploaded to the PC and shown by the browser. Do not forget to save it on the PC.

Integrated Multi Conference Unit – MCU – (option)

This section is dedicated to the functional description of the MCU (Multipoint Control Unit) integrated in the System. The MCU, if not enabled by default, must be enabled by entering an enabling code supplied by the manufacturer.

For an easier reading of this document, MCU stays for **multiconference session**.

Colored keys functions:

Red: associated camera activation

Blue: H.243 activation

Yellow: associated camera activation

Green: still picture display

MCU Technical Specifications

Number Participants:

"9 participants @ 256"

"4 participants @ 768"

"6 participants @ 384"

"3 participants @ 1152"

"5 participants @ 512"

H.264 coding MCU (see note):

"5 participants @ 128"

"4 participants @ 256"

"3 participants @ 384"

Supported Standard:

- ITU-T H.320 ISDN, leased networks.
- ITU-T H.323 IP networks.
- IETF - SIP (RFC3261) IP networks.
- PPPoE.
- Video Coding H.261, H.263+, H.264
- Audio Coding G.711, G.722, G.722.1, G.728.
- LDAP H.350.
- Compliant MCU H.243, H.231.
- Compatible with analog and mobile networks.

Video:

- Frame rate: 15 fps @ 56 -128 kbps,
30 fps @ up to 168 kbps.
- Video Resolution: 4CIF 704 x 576 pixel,
FCIF 352 x 288 pixel, QCIF 176 x 144 pixel,
4CIF 704 x 576 pixel for still images (Annex D:
H.261),
Up to 1024 x 768 over XGA in H.263.
- Chair Control H.243.
- Dial In/ Dial Out capabilities.
- Continuous Presence.
- Encryption.
- H.239 Dual-Video from any site.

Encryption:

- AES Encryption standard H.233, H.234, H.235.

Web management.

Note:

If the conference is managed in automatic mode, once reached the maximum available number of H.264 remote terminals, system will degrade all new participants to H.263.

If the conference is explicitly set to use H.264 video, limitation on terminal numbers are known at the conference start-up

Multiconference Setup

Before activating a multiconference session, configuration is required.

From the **HOME PAGE** select:

SETTINGS / MULTICONFERENCE

The following will be displayed:



In this menu you can set:

- Network Type: IP, ISDN or Mixed.
- Conference Type: allows you to select the number of participants and the desired rate (example: for an MCU IP you select 7@128 from the drop-down menu, which means that the MCU will allow the System to manage a multiconference with a maximum of 7 terminals (including itself), via IP, with a maximum rate of 128K for each connection).
- Preferred Audio Coding
- Preferred Video Coding

Go to the corresponding drop-down menu, press **OK**, with the aid of the arrow keys on the remote control make your selection and press **OK** again to confirm. <Auto> is the default setting.

In addition, you can select the following options:

- Dual Video H.239
- G.722.1
- H.264
- Auto adjust rates and Auto adjust coding

If automatic adaptation is enabled, the System will automatically adapt the multiconference to the audio/video encoding and bit rate of the lowest quality connection within the conference, without excluding any participant.

- Tx Continuous Presence: Enable/Disable transmission of Continuous presence: for multiconferences (at least two participants) all participating sites receive the signals simultaneously from all participating terminals.
- Ask to save scenario: At the close of the multiconference, the system asks whether save in the phonebook all information needed to repeat it, with an editable "conference name".

- **Mode** (only for MCU ISDN or Mixed)
 - Multiple of 64K
 - Multiple of 56K.
- **Cascade Role, Master or Slave**

This option allows you to set up cascaded MCUs in a two-level hierarchy tree. Corresponding to the base node of the cascade there is the Master System, with Slave Systems for the child nodes.

Note

In a mixed-mode MCU session, the user can choose to substitute NIC protocol for ISDN. So in a multiconference with an active NIC connection, no ISDN connections are allowed, and in a multiconference with an active ISDN connection, no NIC connections are allowed.

How to start a multiconference

To establish a multiconference:

1. From the **HOME PAGE**, select the **VIDEO** icon, or press the **Call** key on the remote control. You will enter the **AUDIO AND VIDEO CALL** page.



2. Choose desired MultiConference type: MCU IP, MCU ISDN, MCU (mixed mode).
3. Chose the desired rate and number of participants.
4. If the MCU has not been configured, it is possible to enter the configuration menu previously described by selecting the **CONFIGURE MCU** icon and pressing **OK**.
5. If the MCU has already been configured, go to the **Active Conference** icon and press **OK** to start the multiconference. The same can be obtained by pressing the **CALL** key on the remote control.
6. Local video will be displayed at full screen.
7. To add participants, press the remote control **CALL** key
8. To disconnect participants, press the remote control **DISCONNECT** key.



H.243 function

From the full screen page of MCU manager or a participant terminal is possible to get MCU control, conforming to H.243 protocol, by pressing the **BLUE** key.

A page will appear, where is possible to:

- Request Chair control.
 - Close conference.
- Send local on air.
- For each terminal in the list.
 - Information: connected users.
 - See.
 - Send on air.
 - Disconnect.

Remote terminals disposition and visualization

	"Terminals disposition" icon
	"Video Zoom +" icon
	"Video Zoom -" icon

With MCU on and various connected terminals, is possible to choose disposition and how many video flows should be displayed. From the full screen page of the manager, press **right** or **left** keys to select the "terminals disposition" icon, and press **OK**.

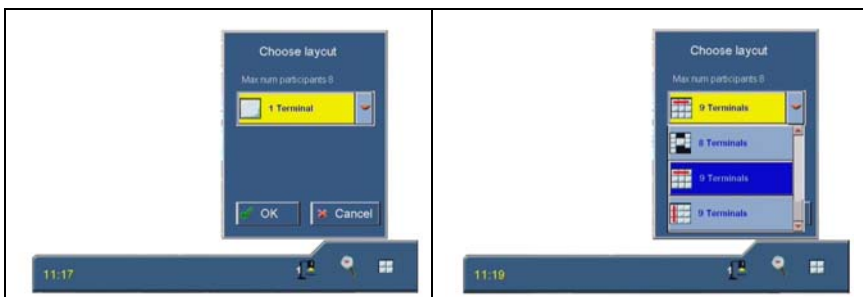











Once the window is opened:

1. By means of **up** and **down** keys choose the visualization mode, and then confirm selection with **OK** key.
2. Close the window by means of the **OK** icon, or with the **X** icon to discard selection.

Note

If **Continuous Presence transmission** is enabled in configuration (see **Multiconference setup chapter**), "terminal disposition" is sent to all terminals

Terminals disposition	Description
Automatic	Always shows all participants. ! Note: This disposition enables Continuous Presence.
1 Terminal 	Show active speaker video flow. ! Note: This disposition enables Voce Switching.
2 Terminals 	Shows (horizontally tiled) two terminals video flows only, active speaker and previous speaker, independently from connected terminals number. ! Note: This disposition enables Continuous Presence Active speaker does not see its video.
2 Terminals 	Shows (vertically tiled) two terminals video flows only, active speaker and previous speaker, independently from connected terminals number. ! Note: This disposition enables Continuous Presence Active speaker does not see its video.
3 Terminals 	Shows three terminals video flows only, independently from connected terminals number, as in picture. ! Note: This disposition enables Continuous Presence.
3 Terminals 	Shows three terminals video flows only, independently from connected terminals number, as in picture. ! Note: This disposition enables Continuous Presence.
4 Terminals 	Shows four terminals video flows only, independently from connected terminals number, as in picture. ! Note: This disposition enables Continuous Presence.
7 Terminals 	Shows seven terminals video flows, independently from connected terminals number, as in picture. ! Note: This disposition enables Continuous Presence.
8 terminals 	Shows eight terminals video flows, independently from connected terminals number, as in picture. ! Note: This disposition enables Continuous Presence.
8 terminals 	Shows eight terminals video flows, independently from connected terminals number, as in picture. ! Note: This disposition enables Continuous Presence.
9 terminals 	Shows nine terminals video flows, as in picture. Squares are used in horizontal order. ! Note: This disposition enables Continuous Presence.
9 terminals 	Shows nine terminals video flows, as in picture. Squares are used in horizontal order. ! Note: This disposition enables Continuous Presence.

By means of **Cancel** key choose if visualize the status bar.

Multiconference Management















Once the first 6 steps of paragraph “How to start a multiconference” have been accomplished, press the **HOME** key on the remote control to display the multiconference management interface.







The window in the centre displays current local video. The following table shows various information icons for the local terminal (the MCU manager). Some of displayed information is also valid for other connected terminals.

MCU control panel icons

MCU manager by means of control panels get information and can interact using following icons.

ICON	STATE	NOTE
	Channel is connecting	
	Channel connected	
	Terminal connected	For terminal disconnection
	Terminal not connected	To make a call
	Microphone active	For Mute activation (The audio is not transmitted)
	Microphone in MUTE	For Mute deactivation
	Video active	For broadcast activation
	Video not active	Terminal not connected
	Previous active speaker	For broadcast activation
	Current active speaker	For broadcast activation
	Video in broadcasting	For broadcast deactivation
	Voice switched	Active speaker in full screen For Continuous Presence activation
	Continuous Presence	All participants are on the screen (default). For Voice Switched activation
	Conference status	For terminal information Stay for "conference status" table

	Encryption not active	Stay for "Encryption"
	Encryption disabled by user	Stay for "Encryption"
	Encryption only in transmission	Stay for "Encryption"
	Encryption active	Stay for "Encryption"

To add participants using the alphanumeric keys of the remote control, go to a video control panel, and select the **HANDSET** icon; press **OK** to start the call procedure.

Three options for choosing a remote user will be presented:

- **Phonebook**
- **Video**
- **Audio**

Alternately, once the **HANDSET** icon has been selected, directly press the **CALL** key on the remote control.

Repeat the above procedure for each terminal to be connected, up to the preset limit.

To add participants to the conference from full screen page, please press the **CALL** key: the **AUDIO – VIDEO CALL** page will appear.

There are three different MCU modes:

- A) **Continuous Presence**
When the second terminal joins the conference, system automatically switches to this mode, which allows all participants to see all connected terminals at the same time. Video windows disposition can be chosen among available by selecting the "Terminals disposition" icon.
- B) **Voice Switched**
MCU manager detects the "active speaker" (person speaking at the moment), and sends his video to all other participants. Active speaker terminal receives video of previous speaker.
- C) **Broadcasted Video**
MCU manager sends selected video to all participants.

In any case MCU manager can switch among the three modes by means of the dedicated icons in the MCU control page.

Terminals status during a MCU

A. Status of MCU manager

By selecting the **Conference Status** icon a window will appear, with information about connection settings of local terminal.

It's moreover possible to:

- Select **Duration** icon to access MCU timing management page
 - It's possible to select **No time limits** or a time for MCU conclusion
 - **Close Now** will immediately close the MCU
 - **OK** to confirm choices
 - **Cancel** to discard changes

B. Status of MCU "Terminal n."

By selecting the **Conference Status** icon a window will appear, with information about connection settings of terminal, number of connected remote terminals, kind of call (outgoing/incoming), terminal number.

It's moreover possible to:

- Select the **Diagnose** icon, with connected terminals only, to visualize connection diagnostics
- Choose between **Always accept** or **Refuse** incoming IP or ISDN calls, with disconnected terminals only.
- Choose **Control Number** for ISDN, to insert the only number allowed to join the conference for that terminal.
- The **OK** icon closes the page.

Ending a Multiconference

There are two ways to end a multiconference:

- A) From the full-screen video page, press the remote control **DISCONNECT** key
 - The **Cancel** icon closes the page without performing any operation
 - By means of **arrow** keys **UP** and **DOWN** you can select and disconnect a participant
 - **Close Now** icon will immediately close the whole MCU (disconnection of all terminals)
- B) From the multiconference management interface, select the **Menu** icon on the status bar and press **OK**.

In both cases the System shows:

- A message asking confirmation for the multiconference end
- A message asking whether to save in the Phonebook all information needed to repeat the multiconference, with an editable **Conference name**

Dual Video in MCU

Dual Video functionality, based on H.239 standard, is available for multiconference calls, even in mixed mode (only SIP participants will not see the dual stream).

To start a Dual Video session in a multiconference:

1. Start a multiconference (see the “How to Start a Multiconference” section)
2. Connect all desired terminals
3. From the terminal (manager included) that want to send the second video, press remote control **Dual** key
4. Select the **V.Input** for the DualVideo and press **OK**
5. Press **YES** icon

Note

One other icon (camera or XGA) present in the status bar means active Dualvideo

System Diagnostics

The System's diagnostics menu allows you to perform tests and checks to verify that the system is properly working.

From the **HOME PAGE** select:

SETTINGS / DIAGNOSTICS

The following page will be displayed:



Terminal test

This option performs an internal test of the system.

The test can be useful to diagnose audio/video problems encountered during a call.

The test uses encoded local audio and video to simulate a connection.

Press any keys to stop the test.

Interfaces

This option performs an internal test of the following interfaces:

- **"AUDIO"**.
For each input and output, peak values, noise and status can be visualized by means of graphical view-meters; in addition, the transmission and reception streams can be seen. Finally, it is possible to generate a tone (Tone Loc.) to test the speaker volume, and the selection of "Tx Tone" during a connection will generate an audible tone at the remote system.
- **"VIDEO"**.
In this section you can view information on the active video input type and the video standard in use.
- **"NETWORK"**.
In this menu you can view information about the detected interfaces
For ISDN accesses an LED status indicator is available:
 - Red** – access is disabled or in error.
 - Yellow** – access is functioning, but Level 1 is not active.
 - Green** – Level 1 is active.

Connection Status

This section contains information about call status, including parameters such as incoming and outgoing audio and video bandwidth, incoming and outgoing video frame rates, and protocols in use.

The **CONNECTION STATUS** page is displayed in a window overlaid on the current video.

The **CANCEL** key on the remote control can be used to change the transparency. To move within the table, press the **OK** key, then use the **up** and **down arrows** keys to navigate. To exit the page, press the **left arrow** keys.

ISDN

In an ISDN call, you can check certain data about the connection: rate, audio encoding, video encoding, frames/sec., and status of data channels.

In addition, by going to the **Accesses** icon and pressing **OK**, you can enter a page of advanced diagnostics, used to monitor in greater detail the state of individual ISDN accesses.

For each access you can see whether it is configured or not, whether it is active or not, and for each single access channel you can gain information such as the state, the number, cause of disconnection, "Error H.221" messages, and the delay.

IP

For IP calls, you can check certain data related to the Audio and Video IP connection: bit rate, audio and video encoding types, frames/packets (for audio), frames/sec. (for video), and number of lost packets.

NIC

For NIC calls you can check a series the following data about the connection: bit rate, audio and video encoding types, frames/sec., and DATA channel status.

Hardware

This section contains basic hardware information such as internal temperature and MAC address. Information about the processor and audio/video system can also be found in the Audio and Video submenus.

Software Versions

This section shows contains information about the software modules installed on the system, including versions, build dates, etc.

Connecting a personal computer

The System can be connected to a personal computer either directly or via a network (LAN) in order to update software, change remote settings or perform diagnostic tests.

Connecting a PC to the System without LAN

To connect the System to a personal computer not connected to a LAN:

1. Connect an Ethernet cable to the System connector and to the network interface card of your PC.
2. From the **HOME PAGE**, navigate through the following menus:
[HOME PAGE / SETTINGS / INSTALLATION / NETWORK INTERFACES / IP / IP CONFIGURATION / IP CONFIGURATION](#)
Ensure that the System belongs to the same subnet as the PC, but has a different address. If this is not true, change the System's IP address and restart the system.
3. Start the browser on your PC. In the address bar, enter the System's IP address. The web page manager will appear.

Connecting to the System via a PC in a LAN

To connect to the System from a PC in a LAN:

1. Ensure that a LAN cable connects the System's rear connector to your LAN. The PC can be connected to a LAN node or to the LAN OUT connector at the rear of the System.
2. Switch on the System.
3. Navigate through the following menus:
[HOME PAGE / SETTINGS / INSTALLATION / NETWORK INTERFACES / IP / IP CONFIGURATION / IP CONFIGURATION](#)
4. If your LAN does not use a DHCP server, leave the Automatic IP Address box unchecked and enter the IP Address, the SubNet mask, Gateway IP Address and the DNS Server IP Address supplied by the network administrator, then restart the System.
5. On the PC, start Internet Explorer. Enter the System's IP address in the address bar of the browser.
6. The web page manager will appear.

Remote management

The System incorporates an integrated network server that allows management of the unit from a remote PC. Through this interface it is possible to:

- Change System settings.
- Execute diagnostic tests.
- To use a web chat for communications between: PC for remote control, local terminal and remote terminal.

Access to the web page

Start a web browser on your PC. Enter the System's IP address in the address bar of the browser.

A request to enter the system password will be displayed. Always enter "**Aethra**" in the User Name field. The password can be changed from the default of "1234" in the system configuration menu (see chapter "Installation-Password" in this manual).

For correct web page viewing in Windows Server 2003 you will need to activate script execution in Internet Explorer by selecting:

TOOLS / INTERNET OPTIONS / SECURITY / CUSTOM LEVEL / SCRIPTING / ACTIVE SCRIPTING / ENABLE

A page very similar to the System user interface **HOME PAGE** (GUI) will be displayed.

From here, you can make a call in the way previously described. The arrangement of the menus for configuration and diagnostics is also the same (GUI).

In addition to the normal menus, a "**Tools**" section and a "**Chat**" section they have been added.

The language of the web interface can be toggled between English and Italian by clicking on the flag displayed at the top centre of the **HOME PAGE**.

When using the web-based management features, use the  icon present on all pages to save changes.

Live Video Streaming

By clicking on the Live Video Streaming window, you can access the STREAMING page where you can see and control Local or Remote video.

When in a call, the transmitted video is the Remote one; during the call, from the V. Input section you can select the video that will be shown in the window:

LOCAL – switches from Remote to Local

AUTOMATIC - switches from Local to Remote

TOOLS Section

From the **WEB HOME PAGE**, click on **TOOLS** icon to access these options.

Where the following downloads are proposed:

- The program DataConf.exe enables you to use NetMeeting 3.xx with ISDN, IP, or NIC calls for multimedia activities (data channels T.120). See section "Managing the Data Conference Software".
- The program AePPTManager.exe enables you to load a PowerPoint presentation in the System.
- The file NoteB.dat enables you to save all the phonebook data (MCU excluded), and can also be used to transfer the data between systems.
- Finally, a module is present that enables you to update the System phonebook data, using files that are compatible with Aethra's proprietary phonebook format.

CHAT Section

The Web Chat allows sending brief and immediate communications in text format from the remote PC (T.140 protocol):

- To only the local terminal
- To only the remote terminal
- To both the terminals

The message sent will be shown as a text overlay on the system monitor.

From the **WEB HOME PAGE**, click on **Chat** icon to access the follow options:

- Flag **Local**, **Remote** or **Local + Remote**: It allows deciding which terminal must receive the message.
- Flag enable/disable **Single Char**: there are two modality for send a message.
 - **"Single Char" mode**. Single Digit, each digit it's sent directly to the video window and shown in scrolling text mode.
 - **"Max 40 Char" mode**. Max 40 digits type the message with maximum 40 digits and press "enter".
- **Text** field. Field for digit the messages.
- **Text History** field. Field for read the old messages.
- **Alert** icon. It allows sending the label of the terminal and the text. The message sent will be shown as a text overlay with red color on the system monitor.

Updating software

1. Download the update to a folder on a connected PC.
2. When executed, the program will display the following:



3. Enter the IP address of the system to be updated in the field labeled Host IP Address.
4. Press Start to begin the download.



Attention: During this procedure, follow the instructions displayed on the monitor. The download process requires a few minutes to complete. When the download has finished, the system will restart automatically.

Data Conference with Microsoft NetMeeting 3.xx

The Data Conference software that has been introduced is compatible with version 3.xx of Microsoft NetMeeting and allows you to connect via a LAN the System to a PC hosting NetMeeting.

This enables a user on a local network to exploit the System as a kind of bridge in order to manage T.120 videoconference data traffic on ISDN, LAN or NIC.

Download Data Conference

The file DataConf.exe is available for download on System web page, in the TOOLS section described above.



It is important to download the file DataConf.ini as well. This enables automatic configuration of the previous program and must be installed in the same folder where the DataConf.exe file was saved.

1. Download the software DataConf.exe;
2. Will be downloaded dc.exe file, start the file.
3. Download the software DataConf.ini
4. Start DataConf.exe.

Use of Data Conference

In order to use the System as a bridge for data transfer, navigate through the system menus as shown:

HOME PAGE / SETTINGS / AUDIO – VIDEO – DATA / DATA CHANNEL

Configure this section as illustrated:

- A) Data Channel: YES
- B) Modem: NO
- C) MLP: T.120
- D) Serial Rate: 115200

For uses over LAN, go to the following sections:

HOME PAGE / SETTINGS / INSTALLATION / NETWORK INTERFACE / IP / H.323 SETTINGS

At this stage:

1. Check the box Use NetMeeting
2. Enter the IP address of the PC hosting NetMeeting.

Managing the DataConference software

Data Conference is typically used when two ISDN or LAN connected users decide to start a conference using T.120 communication.

Start the DataConf.exe program.

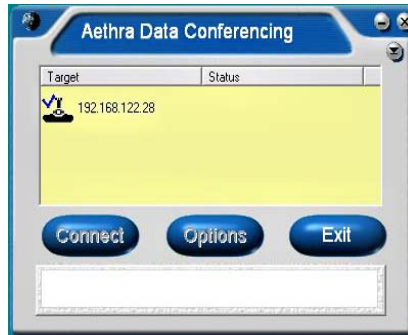

The program creates an automatic connection between the System and the PC. At this point, several items of information concerning the connection are displayed:

- The System IP address.
- The network interface used for video calls.
- The type of call: incoming or outgoing.
- The T.120 data channel active.
- The status of the NetMeeting connection between the two users.

Once the connection has been established, NetMeeting 3.xx is displayed in the foreground and you can perform all data conference management operations.

If you desire to change the IP address of the System, you have to disconnect, press the key Configure and enter the new address to use.

Appendices

IP Network Requirements for Videocommunication

The network requirements for point-point connections between IP videoconferencing terminals are as follows.

The complete network path connecting two IP terminals must have a constant available bandwidth for the whole duration of the connection. The effective bandwidth used on LAN/WAN Full-Duplex network connections is equal to the sum of the Audio Rate and Video Rate, plus approximately 20% for TCP/IP overhead.

In the case of Half-Duplex LAN/WAN networks, the aforementioned bandwidth is doubled. For example, if it is necessary to guarantee a 384K connection for the video and a 64K for the audio, the bandwidth allocated must be at least $(384+64) * 1.2 \approx 540K$ for each Half-Duplex connection. In case of dial-up WAN links, it should be underlined that their efficiency in terms of “useful” bandwidth is approximately half the total available bandwidth.

It is always preferable to use mechanisms such as QoS for WANs because they take into account the total bandwidth required for a videoconference, rather than relying exclusively on over-dimensioning the network. This is necessary for the handling of increasing numbers of simultaneous connections or a network that is already loaded.

The network needs to be set up so that latency and jitter are as low as possible. Extended times for latency and variable jitter can create serious problems, especially in video quality.

It is always preferable for IP terminals to be connected to switched type LAN connections to avoid the traffic generated by terminals being superposed on the normal traffic present on the network.

It is preferable to avoid using NAT-type protocols on router interfaces that route IP packets, since NAT protocols often do not allow the correct routing of connections.

If NAT, firewall or access list implementations are to be used, they must be IP compatible.

NAT – FIREWALL Interoperability

Introduction

There are many strategic advantages for companies that succeed in making all traffic converge from voice applications, video and data to one IP network infrastructure.

Unfortunately, the drive to concentrate all IP communications onto one single network has reduced. The connection between a company's corporate network and the Internet world is accomplished with firewalls and devices using NAT (Network Address Translation), which block voice and video calls via IP. Firewalls block IP traffic for video and voice by preventing any unsolicited communication from the outside. Devices implementing NAT block IP traffic because all equipment on the internal network uses private IP addresses, and can therefore not be contacted from outside the local domain.

There are several solutions to the problem of getting IP communications past NAT and firewalls: bypassing the firewall or NAT device, upgrading the network infrastructure with an Application Level Gateway (ALG), and going out through the firewall or NAT using semi-tunneling connections.

Going around the firewall or NAT device is not the best solution for most companies. Removing the firewall or placing videoconferencing equipment on an unshielded section of the network could seriously compromise the network's security.

Using these devices is very expensive and besides this an access policy for Firewalls and NATs would be needed. These devices should be located along the communication path at every point where a NAT and Firewall are present.

A second solution is the improvement of the network by the introduction of an ALG, but this is intrusive and potentially expensive. ALGs are software packages specifically designed for firewalls from various producers that examine every packet attempting to pass through the firewall in order to determine whether it concerns a known protocol like H.323 or SIP. If the packet contains a known protocol, the Firewall allows it through. However, like Proxies and MCUs that go around firewalls, ALGs also need an access policy for firewalls and every firewall or NAT device needs up-to-date ALG software. Because new protocols are continually being developed, ALG software must be updated frequently.

IP Voice and Video Crossing NAT and Firewall

The use of existing network infrastructures for the transmission of voice, video and data promises interesting strategic advantages for companies of all sizes. Commonly known as "rich media communications" or "Internet Protocol (IP) communications" these technologies for converging networks offer new opportunities to communicate, coordinate and collaborate with customers, suppliers, commercial partners and others all over the world.

Unfortunately, the protocols used for IP communications conflict with most of the security mechanisms for networks (such as Firewalls and NAT), resulting in protracted or late implementation times for IP video and voice applications.

Firewalls and NATs – How they work

In an IP network, every device is assigned a unique IP address. All computers, telephones, and videoconference terminals have at their disposal approximately 65,000 ports for the purpose of establishing communication channels to transmit data to other devices on the network.

Messages between IP network devices are composed of packets that contain the following information:

- the IP address of the terminal that has generated the message, the port number from which the message has been sent.
- the IP address of the destination terminal, the port number at the destination.
- the data being sent.

Firewalls

Companies that allow connection to the Internet by their employees typically install a firewall in order to prevent external access of or tampering with internal data.

The firewall examines the destination IP address and port number of every packet received from outside. Usually, firewalls are configured in such a way that if a computer from inside the firewall requests data from a computer outside the firewall, the response packets will be allowed through from the external computer, but only if they are sent to the IP address and port of the internal computer that generated the request.

If the Firewall receives a packet destined for a computer that is located internally and determines that the destination computer has not initiated any communication, the firewall discards the incoming packet.

Firewalls are nearly always configured to block all incoming traffic that has not been explicitly requested. Internal web servers are the exception: they must be accessible from the outside. To allow this, the network administrator configures the Firewall to let through packets destined for port 80 of the IP address of the web server. This operation allows external users to send requests to connect to the company's web server in order to access data on that server.

NAT (Network Address Translation)

Network Address Translation is an Internet standard that allows a LAN (Local Area Network) to use a set of IP addresses for internal traffic and another address (or set of addresses) to connect to services on an external network (the internet, for example). Devices that implement NAT are located at boundaries between the LAN and the external network, and their purpose is to provide translation of IP addresses for all packets that are destined for the external network. Many organizations use NAT as a security mechanism because it masks the internal IP addresses—if hackers do not know the IP address of a machine, they cannot attack it and cause disruptions. NAT also allows a company to use more IP addresses than they might otherwise be allocated. Since these addresses are only used internally, there is no problem with IP address conflicts with other organizations.

Problems with Video and Voice Communications on NAT/Firewall Protected Networks

The IP based voice and video protocols like H.323 require that terminals be capable of establishing audio-video communication channels using IP addresses and data ports. In this situation, a problem arises: terminals must "listen" for incoming calls to establish IP connections, but the firewall is generally configured in such a way as not to allow packets past that are not expressly requested. Even if the network administrator left a port open for the terminal to receive notification of a call (port 1720, designated as a "well-known TCP port") the video and voice communication protocols for IP necessitate the opening of other ports in order to receive control messages and open audio and video channels.

The identities of these additional ports are determined dynamically, not in advance, meaning that the network administrator would have to open all the firewall ports to allow video and voice communication, thus virtually disabling the firewall. Network administrators are unlikely to do this (and wisely so), since it effectively eliminates network security policies. NAT also creates an obstacle for voice and video communications over IP. NAT allows an organization to assign private IP addresses to machines on the local network, but routers that control the flow of data towards the Internet can handle only packets with routable addresses or public IP addresses.

A terminal located behind the NAT device on the LAN can initiate communication with any other terminal in the same LAN because the IP addresses within the LAN are routable, meaning that it is possible to have subnets in a company managed by an internal router. This allows the establishment of audio-video communications on different branches of the subnet.

Because they have private addresses, and are therefore not accessible from outside the NAT, terminals on the LAN cannot be reached by externally originating calls. Even if they initiate calls to external terminals, a problem still arises. When the call is initiated, the IP address of the calling terminal is contained in the payload of the packet sent. The destination terminal receives call setup packets, examines them and starts to transmit audio and video towards the terminal from which the call was received, and from which the IP address was obtained by examining the contents of the received packets.

If this IP address is private, the router for Internet access discards the audio and video packets sent from the terminal external to NAT towards the internal terminal because the packets sent were non-routable. The connection between two terminals appears to be successful but in reality the NAT-internal terminal never receives the audio or video from the external terminal.

Solution for the NAT/Firewall Problem

The only equipment that does not create any of the problems described above is a NAT/firewall H.323-compatible device. Such a firewall does not block the TCP 1720 port and allows access to the other, dynamically-determined H.323 ports. Videoconferencing systems usually have private IP addresses that are not accessible from external routers. To allow calls to function properly, the network administrator can define static NAT (a permanent association between a private IP address and a public IP address reserved for H.323 videoconferences) for every terminal that must be accessible from an external connection.

The NAT device substitutes the static IP address in the payload and header setup packet sent from the internal terminal to the external terminal. The destination terminal uses that address for addressing the reply packets, which are routed through the NAT device to the internal terminal.

Firewall ALG

Application Level Gateways (ALGs) are firewalls programmed to recognize specific IP protocols like H.323. Instead of looking only at the information contained in packet headers to determine whether to transmit or block packets, ALGs analyze in detail the data contained in the payload packet. The H.323 protocol inserts important control information such as audio and video port identification in the payload packets. The terminal expects to receive audio and video connections from the remote calling terminal on these ports. By analyzing which port the terminal expects to use, the ALG dynamically opens only those ports, leaving the others closed to preserve network security. An example of a firewall ALG follows.

The Aethra Application Level Gateway is present in the Aethra Stargate xDSL Router and allows any videoconferencing terminal, independent of its manufacturer, resolve the NAT/firewall problem. The Stargate router is capable of checking every incoming and outgoing H.323 call and dynamically opening only the ports being used for the H.323 videoconference.

The Stargate router also supports NAT functionality and is therefore capable of substituting the public NAT address for the private IP address automatically inserted in the H.323 payload packets by the internal terminal. When the Aethra ALG functionality is used with an Aethra videoconferencing system, the "Aethra NAT" function of the videoconferencing system must be disabled because the network equipment is H.323 compatible.

Wireless Cards

The minimal cards wireless requirement to use the system in wireless nets is standard Wi-Fi PCMCIA IEEE 802.11b.

Some models of cards wireless supported:

- BENQ AWL100
- CISCO/AIRONET AIRPCM 350
- All AGERE/ORINOCO compatible cards.

For other information relative to the compatibility **Wi-Fi 802.11b, 802.11g, 802.11a** please contact Help Desk Aethra Telecomunicazioni SpA.

Mail: service.center@aethra.com

Technical specifics

<p>Supported Standards</p> <ul style="list-style-type: none"> ITU-T H.320: ISDN, leased networks ITU-T H.323: IP networks IETF-SIP (RFC3261): IP networks PPPOE Video : H.261, H.263+, H.264, H.239, H.241 Audio : G.711, G.722, G.722.1, MPEG4 AAC-LD, G.728, G.722.1 Annex C* Data: T.120 LDAP: H.350 MCU compatibility: H.243, H.231 * Software release v11 <p>Transmission</p> <ul style="list-style-type: none"> Bit rate: <ul style="list-style-type: none"> 56 kbps + 768 kbps over ISDN BRI¹ 56 kbps + 2 Mbps over ISDN PRI^{1,2} 64 kbps + 2 Mbps over IP (H323/SIP) 64 kbps + 4 Mbps over IP (H323/SIP) option Asymmetric rates 56 kbps + 2 Mbps over V.35/Leased² ¹ Up to 384 kbps with sw option, up to 768 kbps with hw option ² With hw option ** In North America ISDN PRI/T1 at 1544 kbps (ANSI T1 recommendations) • Simultaneous video motion coding and PC presentations from the XGA input. <p>Video</p> <ul style="list-style-type: none"> • Frame rate: 15 fps @ 56 kbps - 128 kbps 30 fps @ 168 kbps - 4 Mbps • Video resolution: <ul style="list-style-type: none"> w720p 1280 x 720 pixels (receiving only) 4CIF 704 x 576 pixels FCIF 352 x 288 pixels QCIF 176 x 144 pixels 4CIF 704 x 576 pixels for still images (H.261 Annex D) 4SIF 704 x 480 pixels SIF 352 x 240 pixels QSIF 176 x 120 pixels 4SIF 704 x 480 pixels for still images (H.261 Annex D) Up to 1024 x 768 pixels over XGA in H.263 • Remote camera control: H.281 (H.320 - H.323) <p>Audio</p> <table border="1"> <thead> <tr> <th>Audio</th> <th>Band</th> <th>Bit rate:</th> </tr> </thead> <tbody> <tr> <td>G.711</td> <td>300-3400 Hz</td> <td>48/56/64 kbps</td> </tr> <tr> <td>G.728</td> <td>50-3400 Hz</td> <td>16 kbps</td> </tr> <tr> <td>G.722</td> <td>50-7000 Hz</td> <td>48/56/64 kbps</td> </tr> <tr> <td>G.722.1</td> <td>50-7000 Hz</td> <td>24/32 kbps</td> </tr> <tr> <td>G.722.1 AnnexC</td> <td>50-14000 Hz</td> <td>24/32/48 kbps</td> </tr> <tr> <td>AAC-LD</td> <td>50-14000 Hz</td> <td>48/56/64 kbps</td> </tr> </tbody> </table> <ul style="list-style-type: none"> • Echo cancellation Full-duplex • Adaptive post filtering • Automatic Gain Control (AGC) • Automatic Noise Suppression <p>Audio Tracking</p> <ul style="list-style-type: none"> • Tracking Enhanced Voice Tracking • Coverage max. 6 m, recommended 3 m • Location ±60° horizontal, ±25° vertical <p>Hi-Band Digital Microphone Pod</p> <ul style="list-style-type: none"> • Range: 360° • Response: 50-14000 Hz • Microphones: 3 • Mute button • Up to 2 pods in a daisy-chain configuration 	Audio	Band	Bit rate:	G.711	300-3400 Hz	48/56/64 kbps	G.728	50-3400 Hz	16 kbps	G.722	50-7000 Hz	48/56/64 kbps	G.722.1	50-7000 Hz	24/32 kbps	G.722.1 AnnexC	50-14000 Hz	24/32/48 kbps	AAC-LD	50-14000 Hz	48/56/64 kbps	<p>Built-in Camera</p> <ul style="list-style-type: none"> • Resolution 752 x 582 pixels • Presets 122 presets • H. angle of view 6.6 to 65 degrees • Zoom 40x (10x optical + 4x digital) <p>Supported Monitor</p> <ul style="list-style-type: none"> • Format: PAL, NTSC, HighDef • Single, Dual monitor, HighDef • PIP and PAP function • 16:9 • Dual Monitor Emulation <p>Network Interfaces</p> <ul style="list-style-type: none"> • Basic version Ethernet 2-Port 10/100BASE-T full-duplex with integrated switch Ethernet 2 RJ-45 • Optional ISDN 1/3/6 BRI with integrated channel aggregator 1/3/6 RJ-45 or 1 E1/T1 PRI with integrated channel aggregator 1 RJ-45 or Leased networks X.21/V.35/RS366/RS449 44 pin Hi/Den or G.703 1 RJ-45 <p>Network Protocols</p> <ul style="list-style-type: none"> • TELNET, HTTP, SNMP, DNS, DHCP, RTP/RTCP, TCP/UDP, ARP <p>Network Features</p> <ul style="list-style-type: none"> • Differentiated Service (DIFFSERV), IP Precedence, IP Type of Service (ToS), Auto Gatekeeper Discovery, Clever Packets Management (AeCPM) <p>Audio/Video Interfaces</p> <ul style="list-style-type: none"> • Video inputs <table border="1"> <tr> <td>Main camera</td> <td>Integrated Y/C, not accessible</td> </tr> <tr> <td>VCR</td> <td>Composite (RCA)</td> </tr> <tr> <td>Doc. Cam 1</td> <td>S-video (Mini-DIN)</td> </tr> <tr> <td>Doc. Cam 2</td> <td>S-video (Mini-DIN)</td> </tr> <tr> <td>Doc. Cam 3</td> <td>Composite (RCA)</td> </tr> <tr> <td>XGA</td> <td>DVI-I</td> </tr> </table> • Video outputs <table border="1"> <tr> <td>Monitor 1</td> <td>Composite (RCA)</td> </tr> <tr> <td></td> <td>S-video (Mini-DIN)</td> </tr> <tr> <td>Monitor 2</td> <td>S-video (Mini-DIN)</td> </tr> <tr> <td></td> <td>with monitor detect</td> </tr> <tr> <td>VCR</td> <td>Composite (RCA)</td> </tr> <tr> <td>XGA</td> <td>DVI-I</td> </tr> </table> • Audio inputs <table border="1"> <tr> <td>Connection</td> <td>Level</td> <td>Connector</td> </tr> <tr> <td>2x Pod mic 360°</td> <td>Dig</td> <td>RJ-11 6/6</td> </tr> <tr> <td>Aux. mic</td> <td>Mic</td> <td>Stereo Jack 3.5 mm</td> </tr> <tr> <td>Audio In</td> <td>Line</td> <td>RCA</td> </tr> <tr> <td>VCR</td> <td>Line</td> <td>2 RCA (L/R)</td> </tr> </table> • Audio outputs <table border="1"> <tr> <td>Connection</td> <td>Level</td> <td>Connector</td> </tr> <tr> <td>Monitor 1</td> <td>Line</td> <td>2 RCA (L/R)</td> </tr> <tr> <td>VCR</td> <td>Line</td> <td>2 RCA (L/R)</td> </tr> </table> <p>HighDef (XGA)</p> <ul style="list-style-type: none"> • Input VGA, SVGA, XGA, WXGA, SXGA • Output VGA, SVGA, XGA, WXGA, SXGA <p>Auxiliary Interfaces</p> <ul style="list-style-type: none"> • Data RS232 Mini-DIN 8-pin with DB9 adapter • Diagnostics RS232 Mini-DIN 8-pin • VISCA RS232 Mini-DIN 8-pin <ul style="list-style-type: none"> • supports Canon or Sony, aux PTZ camera • PC card 1 PCMCIA, type II for Wi-Fi card 	Main camera	Integrated Y/C, not accessible	VCR	Composite (RCA)	Doc. Cam 1	S-video (Mini-DIN)	Doc. Cam 2	S-video (Mini-DIN)	Doc. Cam 3	Composite (RCA)	XGA	DVI-I	Monitor 1	Composite (RCA)		S-video (Mini-DIN)	Monitor 2	S-video (Mini-DIN)		with monitor detect	VCR	Composite (RCA)	XGA	DVI-I	Connection	Level	Connector	2x Pod mic 360°	Dig	RJ-11 6/6	Aux. mic	Mic	Stereo Jack 3.5 mm	Audio In	Line	RCA	VCR	Line	2 RCA (L/R)	Connection	Level	Connector	Monitor 1	Line	2 RCA (L/R)	VCR	Line	2 RCA (L/R)	<p>Closed Captioning/Text Chat</p> <ul style="list-style-type: none"> • T.140 text chat, available from Web <p>User Interface</p> <ul style="list-style-type: none"> • Multilingual on-screen graphic user interface • User selectable languages: Italian, English, French, Spanish, German, Portuguese, Norwegian, Swedish, Russian, Czechoslovakian, Hungarian, Polish, Finnish, Simplified Chinese, Traditional Chinese, Japanese, Korean • Infrared remote control for full function control • Contextual help • Diagnostics and management functions • Call progress monitoring • Supports AMX™ or Crestron™ • Customizable Graphic User Interface • Web streaming function: UNICAST and MULTICAST compatible with QuickTime™ <p>Multipoint Function (option)</p> <ul style="list-style-type: none"> • Integrated MCU H.320, H.323 and SIP mixed mode <ul style="list-style-type: none"> up to 8 participants up to 9 participants* • Compatible with analog and mobile networks • Video coding H.261, H.263+, H.264* • Audio coding G.711, G.722, G.722.1, G.728 • Chair control H.243 • Dial-In/Dial-Out capabilities • Continuous Presence • Encryption • H.239 Dual-video from any site * Software release v11 <p>Encryption</p> <ul style="list-style-type: none"> • AES encryption standard H.233, H.234, H.235 • NIST (National Institute of Standards & Technology) certified <p>Web management</p> <p>All the configuration, call, diagnostics and management functions are accessible using the following web browsers: Microsoft® Internet Explorer™, Netscape Navigator™.</p> <p>Remote Diagnostics and Management</p> <table border="1"> <thead> <tr> <th></th> <th>Local</th> <th>Web Browser</th> <th>SNMP</th> </tr> </thead> <tbody> <tr> <td>Self test</td> <td>Yes</td> <td>Yes</td> <td>Yes</td> </tr> <tr> <td>Diagnostics</td> <td>Yes</td> <td>Yes</td> <td>Yes</td> </tr> <tr> <td>Configuration</td> <td>Yes</td> <td>Yes</td> <td>Yes</td> </tr> <tr> <td>Call</td> <td>Yes</td> <td>Yes</td> <td></td> </tr> <tr> <td>Error tracking</td> <td>Yes</td> <td>Yes</td> <td>Yes</td> </tr> </tbody> </table> <p>Integrated Presentation</p> <ul style="list-style-type: none"> • Supported applications Microsoft® PowerPoint® • Multimedia support T.120 <p>Power Supply</p> <ul style="list-style-type: none"> • 100-240 Vac 50-60 Hz 1.5 A Max <p>Dimensions</p> <ul style="list-style-type: none"> • VEGA X5 <table border="1"> <tr> <td>Width</td> <td>54 cm (21.25")</td> </tr> <tr> <td>Height</td> <td>22.5 cm (8.85")</td> </tr> <tr> <td>Depth</td> <td>23 cm (9.05")</td> </tr> </table>		Local	Web Browser	SNMP	Self test	Yes	Yes	Yes	Diagnostics	Yes	Yes	Yes	Configuration	Yes	Yes	Yes	Call	Yes	Yes		Error tracking	Yes	Yes	Yes	Width	54 cm (21.25")	Height	22.5 cm (8.85")	Depth	23 cm (9.05")
Audio	Band	Bit rate:																																																																																																			
G.711	300-3400 Hz	48/56/64 kbps																																																																																																			
G.728	50-3400 Hz	16 kbps																																																																																																			
G.722	50-7000 Hz	48/56/64 kbps																																																																																																			
G.722.1	50-7000 Hz	24/32 kbps																																																																																																			
G.722.1 AnnexC	50-14000 Hz	24/32/48 kbps																																																																																																			
AAC-LD	50-14000 Hz	48/56/64 kbps																																																																																																			
Main camera	Integrated Y/C, not accessible																																																																																																				
VCR	Composite (RCA)																																																																																																				
Doc. Cam 1	S-video (Mini-DIN)																																																																																																				
Doc. Cam 2	S-video (Mini-DIN)																																																																																																				
Doc. Cam 3	Composite (RCA)																																																																																																				
XGA	DVI-I																																																																																																				
Monitor 1	Composite (RCA)																																																																																																				
	S-video (Mini-DIN)																																																																																																				
Monitor 2	S-video (Mini-DIN)																																																																																																				
	with monitor detect																																																																																																				
VCR	Composite (RCA)																																																																																																				
XGA	DVI-I																																																																																																				
Connection	Level	Connector																																																																																																			
2x Pod mic 360°	Dig	RJ-11 6/6																																																																																																			
Aux. mic	Mic	Stereo Jack 3.5 mm																																																																																																			
Audio In	Line	RCA																																																																																																			
VCR	Line	2 RCA (L/R)																																																																																																			
Connection	Level	Connector																																																																																																			
Monitor 1	Line	2 RCA (L/R)																																																																																																			
VCR	Line	2 RCA (L/R)																																																																																																			
	Local	Web Browser	SNMP																																																																																																		
Self test	Yes	Yes	Yes																																																																																																		
Diagnostics	Yes	Yes	Yes																																																																																																		
Configuration	Yes	Yes	Yes																																																																																																		
Call	Yes	Yes																																																																																																			
Error tracking	Yes	Yes	Yes																																																																																																		
Width	54 cm (21.25")																																																																																																				
Height	22.5 cm (8.85")																																																																																																				
Depth	23 cm (9.05")																																																																																																				

Troubleshooting

PROBLEM	SOLUTION
Nothing displayed on monitor.	Check that the System is switched on. Check that the System monitor is on by pushing the on/off key at the front of the monitor. If the problem persists, contact the Aethra Help Desk.
I see no video camera signal in Self View and the picture is dark.	Check that the integrated video camera has no objects obscuring the lens. Select as the input the video camera called "Room" using either the remote control or the web interface. If the problem persists, contact the Aethra Help Desk.
No audio transmitted.	Check that there are no objects close to the microphone. Use the integrated diagnostics (see related manual section). If the problem persists, contact the Aethra Help Desk.
The LAN lamp (LED) is flashing, but I cannot successfully PING the system.	Check that the system's IP address is not duplicated in the network. If the problem persists, contact the Aethra Help Desk.
I cannot establish a data connection between the two systems.	Check that the data channel is enabled (see related section in this manual). Check that the IP of the DataConf is the same as that of the system to be connected. If the connection is IP, make sure that the check box "Use NetMeeting" is checked and the PC IP address to be connected is correct (see relevant section in this manual). If the problem persists, contact the Aethra Help Desk.
I cannot make an IP connection and my IP address is correct.	Check that the system is switched on. Check that the system can be reached using PING. Check that the Gatekeeper for both systems is enabled/disabled. If the problem persists, contact the Aethra Help Desk.
The Self View picture is black and white and is rolling from bottom to top.	Check that the video-standard used (NTSC or PAL) is correctly selected in the menu: INSTALLATION → LOCATION
The picture transmitted from my equipment is too dark.	Ensure that the video camera is not pointing at a luminous source (neon light, window etc.).
Audio received is unclear and you only hear the audio in bursts.	Place the integrated microphone farther away from any speakers (TV, system speakers etc.). Ensure that the volume is not too high and that echo cancellation is activated.

Glossary

AACLD Advanced Audio Coding Low Delay

AES Advanced Encryption Standard

AGC: Automatic Gain Control.

BRI Basic Rate Interface

CD Collision Detection

CE Commitee European

CIF Common Intermediate Format

CLIR Calling Line Identity Restriction

CODEC Coder/Decoder

COLR Connected Line Identity Restriction

CRC Cyclic Redundancy Checking

CSU Channel Service Unit

CTS Clear To Send

DHCP Dynamic Host Configuration Protocol

DTR Data Transfer Rate

DVI (-I) Digital Video Interface (integrated)

IEC International Electrotechnical Commission

IP Address Internet Protocol Address

ISDN Integrate Services Digital Network

ISP Internet Service Provider

LAN Local Area Network

MCU Multi-point Control Unit

MIC Microphone

MSN Multiple Subscriber Number

NAT Network Address translation

NR Noise Reduction

NSF Non Standard Facility

NT Network Termination

NTSC National Television Systems Committee

PABX Private Automatic Branch Exchange

PAL Phase Alternation Line

PBX Private Branch Exchange

PC Personal Computer

PiP Picture-In-Picture

PRI Primary Rate Interface

QCIF Quarter Common Intermediate Format

QoS Quality of Service

Router A device that attaches two or more network devices and forwards data accordingly.

RTS Ready To Send

SIF Source Input Format

SNMP Simple Network Management Protocol

SPID Service Provider Identification

SQCIF Sub-Quarter Common Intermediate Format

SVGA Super Video Graphics Array

TCP/IP Trasmission Control Protocol/Internet Protocol

TCS Terminal Control String

TOS Type Of Service

TTL Time To Live

UDP User Datagram Protocol

UL Underwriters Laboratories

VCR Video Cassette Recorder

VGA Video Graphics Array

VISCA Video System Control Architecture

VNC Virtual Network Computing

WAN Wide Area Network

XGA Extended Graphics Array

USE AND STORAGE CONDITIONS

OPERATING TEMPERATURE	+0°C ÷ +40 °C
RELATIVE OPERATING HUMIDITY	10% ÷ 93 % (without condensation)
STORAGE TEMPERATURE	-40 ÷ +70 °C

REFERENCE REGULATIONS (CE MARK AND RELIABILITY TESTS)

STORAGE	EN 60068-2-1 Test AB (IEC 60068-2-1) EN 60068-2-2 Test BB (IEC 60068-2-2)
TRANSPORTATION	IEC 60068-2-32 Test ED - METHOD 1 IEC 60068-2-64 Test FDB (CEI 50-6/9)
OPERATING CONDITIONS	CEI 50-3 EN 60068-2-1 Test AB (IEC 60068-2-1) EN 60068-2-2 Test BB (IEC 60068-2-2) IEC 60068-2-14 Test NB IEC 60068-2-56 Test CB IEC 60068-2-6 Test FC IEC 60068-2-31 Test EC IEC 60068-2-32 Test ED - METHOD 1 IEC 60068-2-64 Test FDB (CEI 50-6/9)
EMC	EN 55022 EN 55024 EN 61000-3-2 EN 61000-3-3 FCC15
SAFETY	EN 60950-1 (IEC 60950-1)
CONNECTION TO TELECOMMUNICATION NETWORK	TIA-968-A 47 CFR PART 68 IC CS-03



Aethra S.p.A.

Via Matteo Ricci, 10
60126 Ancona (Italy)

Tel: +39.071.218981

Fax: +39.071.887077

Video: +39.071.2189701

Email: info.aethra@aethra.com www.aethra.com

Cod. 074201010GB